

# FIRE PROTECTION SYSTEMS CATALOG

G-105 updated 04/2015



 **victaulic**<sup>®</sup>

---

WHERE  
INNOVATION  
AND SOLUTIONS  
ARE JOINED  
TOGETHER



Since the first patent in 1919, Victaulic® has delivered innovative pipe joining solutions that help customers succeed worldwide. Look inside many of the world's most recognizable landmarks and industrial facilities, and you'll find Victaulic solutions at work making bold design innovations possible, speeding time to completion, allowing for unpredictable seismic movements and setting the stage for scalability.

Today, Victaulic supports its customers with manufacturing facilities and branches located around the globe including our world headquarters location in Easton, Pennsylvania, USA. Our international presence ensures that our worldwide customers are served with speed and efficiency.

As the world's leading producer of grooved mechanical pipe joining systems, Victaulic has been delivering global innovative solutions across diverse business lines including fire protection, building services, clean water and wastewater, industrial construction, maritime, mining, oil, gas and chemical, power generation as well as custom castings.

From concept to commissioning, Victaulic provides the technologies and services necessary to simplify your next project.

## TABLE OF CONTENTS

1	VicFlex™ Sprinkler Fitting System
9	Couplings
17	Fittings
19	Hole Cut System
21	Valves and Accessories
29	Devices and Accessories
41	Automatic Sprinklers
55	Victaulic Vortex™
57	Specialty Systems
61	Pipe Preparation Tools
77	Design Data
81	Index





INTRODUCING

# VICTAULIC FIRE.COM

## #1 RESOURCE FOR ALL THINGS FIRE PROTECTION

- Find content with **Fewer Clicks** – 100% Fire Protection Focused
- New Fire Protection **Mega Menus** and **Faceted Search** Features
- **Simple, Clear, Distinct** – Victaulic® Fire Protection



---

# CONTINUING EDUCATION

Victaulic® is now offering a wide variety of continuing education courses. From one-hour seminars to full-day events, these courses provide education on key industry concepts and Victaulic solutions. Created for owners, engineers, contractors, the inspection community, and anyone else seeking to expand their knowledge of Victaulic and the industry surrounding the grooved mechanical market.

For more information on the Victaulic Continuing Education Courses or to schedule your training, please contact your local sales representative or email us at:

[VictaulicUniversity@victaulic.com](mailto:VictaulicUniversity@victaulic.com)



---

# CONSTRUCTION PIPING SERVICES



















Drawing, BIM coordination and software solutions for the fire protection industry. [Victaulicfire.com/CAD](http://Victaulicfire.com/CAD) offers an extensive library of CAD files and software product content created in each software's native platform.



## VicFlex™ Sprinkler Fitting System

Victaulic® offers a comprehensive portfolio of *VicFlex* sprinkler fitting systems, fully engineered and manufactured by Victaulic for consistent installation and performance. *VicFlex* sprinkler fitting systems offer confidence by providing 100% kink resistance and the tightest bends in the market. Up to 10× faster than threaded black pipe, *VicFlex* eliminates messy cutting tools and custom arm-over fabrication. The *VicFlex* system features brackets, hoses and fittings for a wide variety of sprinkler system applications including: commercial suspended ceilings, commercial metal or wood stud hard lid/drywall ceilings, block wall institutional spaces, clean room environments, or industrial duct systems.



<b>Hoses</b>	<b>page</b>	<b>Brackets (Specialty Systems)</b>	<b>page</b>
 <i>VicFlex</i> Braided Hose (Series AH2)	2	 <i>VicFlex</i> for Surface Mount (Style AB3)	6
 <i>VicFlex</i> Braided High Pressure Hose (Series AH2-300)	2	 <i>VicFlex</i> for Cold Storage (Style AB6)	6
 <i>VicFlex</i> Braided Hose (Series AH1)	2	 <i>VicFlex</i> for Duct (Series AQD)	7
 <i>VicFlex</i> Braided Hose (Series AH4)	3	 <i>VicFlex</i> for Clean Rooms (Series AQC)	7
 <i>VicFlex</i> Corrugated Hose (Series AH5)	3		
		<b>Accessories</b>	<b>page</b>
		 <i>VicFlex</i> Reducer Nipples and Elbows	7
		<b>Brackets (Commercial Ceilings)</b>	<b>page</b>
 <i>VicFlex</i> Bracket (Style AB1)	3		
 <i>VicFlex</i> Bracket (Style AB2)	4		
 <i>VicFlex</i> Bracket (Style AB7)	4		
 <i>VicFlex</i> Bracket (Style AB7 Adjustable)	4		
 <i>VicFlex</i> Bracket (Style AB4)	5		
 <i>VicFlex</i> Bracket (Style AB9)	5		
 <i>VicFlex</i> Bracket (Style AB8)	5		
 <i>VicFlex</i> Bracket (Style AB10)	6		



## VicFlex™ Braided Hose

SERIES AH2

[Download submittal 10.85](#) for complete information

- Tightest bends available; 100% Victaulic® design and manufacturing
- Up to 10x faster than threaded black pipe, 100% kink resistant
- Minimum bend radius: cULus – 2" | 51 mm, FM – 7" | 178 mm, VdS – 3" | 76.3 mm
- Sizes 31 – 72" | 790 – 1830 mm
- Pressures up to 232 psi | 1600 kPa | 16 bar

**Approvals/Listings:**



## VicFlex™ Braided High Pressure Hose

SERIES AH2-300

[Download submittal 10.84](#) for complete information

- High pressure hose; 100% Victaulic design and manufacturing
- Up to 10x faster than threaded black pipe, 100% kink resistant
- Minimum bend radius: FM – 7" | 178 mm
- Sizes 31 – 72" | 790 – 1830 mm
- Pressures up to 300 psi | 2068 kPa | 21 bar

**Approvals/Listings:**



## VicFlex™ Braided Hose

SERIES AH1

[Download submittal 10.85](#) for complete information

- Flexible stainless steel hose, for use in suspended or hard-lid ceilings
- Up to 10x faster than threaded black pipe, 100% kink resistant
- Minimum bend radius: cULus – 3" | 76 mm, FM – 7" | 178 mm, VdS – 3" | 76 mm
- Sizes 31 – 72" | 790 – 1830 mm
- Pressures up to 232 psi | 1600 kPa | 16 bar

**Approvals/Listings:**





## VicFlex™ Sprinkler Fitting System



## Approvals/Listings:



## VicFlex™ Braided Hose

## SERIES AH4

[Download submittal 10.85](#) for complete information

- Flexible stainless steel hose, for use in suspended or hard-lid ceilings
- Up to 10× faster than threaded black pipe, eliminate messy cutting tools
- Minimum bend radius: FM – 7" | 178 mm, VdS – 3" | 76.3 mm
- Sizes 31–72" | 790–1830 mm
- Pressures up to 232 psi | 1600 kPa | 16 bar



## Approvals/Listings:



## VicFlex™ Corrugated Hose

## SERIES AH5

[Download submittal 10.89](#) for complete information

- Flexible stainless steel hose, for use in suspended ceilings
- Up to 10× faster than threaded black pipe, eliminate messy cutting tools
- Minimum bend radius: cULus – 4" | 102 mm
- Sizes 24–72" | 610–1830 mm
- Pressures up to 175 psi | 1207 kPa | 12 bar

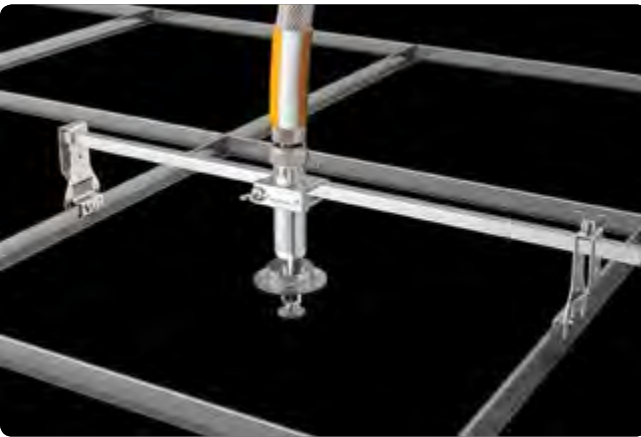

## Approvals/Listings:



## VicFlex™ Bracket with Center-Of-Tile and Tile-Install Features

## STYLE AB1

[Download submittals 10.84](#) and [10.85](#) for complete information

- One-piece bracket, for suspended or hard-lid ceilings
- Allows installation before ceiling tile, eliminate messy cutting tools
- Sizes 24" | 610 mm and 48" | 1219 mm

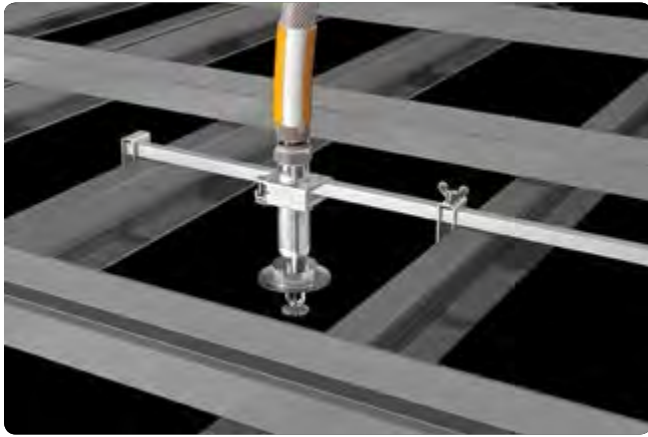

## VicFlex™ Bracket with Vertical Alignment Center Bracket

STYLE AB2

[Download submittals 10.84](#) and [10.85](#) for complete information

- One-piece bracket, for suspended or hard-lid ceilings
- Allows installation before ceiling tile, eliminate messy cutting tools
- In-Room elevation center bracket allows vertical adjustment without braking the ceiling plane
- Sizes 27½" | 700 mm and 55" | 1400 mm

Approvals/Listings:



## VicFlex™ Bracket

STYLE AB7

[Download submittals 10.84, 10.85, and 10.89](#) for complete information

- One-piece bracket, for suspended or hard-lid ceilings
- Up to 10x faster than threaded black pipe, eliminate messy cutting tools
- Sizes 24" | 610 mm and 48" | 1219 mm

Approvals/Listings:



## VicFlex™ Bracket

STYLE AB7 ADJUSTABLE

[Download submittals 10.84, 10.85, and 10.89](#) for complete information

- One-piece bracket, for suspended or hard-lid ceilings
- Up to 10x faster than threaded black pipe, eliminate messy cutting tools
- Sizes 27½" | 700 mm and 55" | 1400 mm

Approvals/Listings:



## VicFlex™ Sprinkler Fitting System



## Approvals/Listings:



## VicFlex™ Bracket for Hat Channel with Adjustable-From-Below Center Bracket

STYLE AB4

[Download submittals 10.84](#) and [10.85](#) for complete information

- One-piece bracket, for hard-lid ceilings with hat furring channel grid system
- Up to 10x faster than threaded black pipe, eliminate messy cutting tools
- In-room elevation center bracket allows vertical adjustment without braking the ceiling plane
- Sizes 27½" | 700 mm and 55" | 1400 mm



## Approvals/Listings:



## VicFlex™ Bracket for Hat Channel

STYLE AB9

[Download submittals 10.84](#) and [10.85](#) for complete information

- One-piece bracket, for hard-lid ceilings with hat furring channel grid system
- Up to 10x faster than threaded black pipe, eliminate messy cutting tools
- Sizes 24" | 610 mm and 48" | 1219 mm

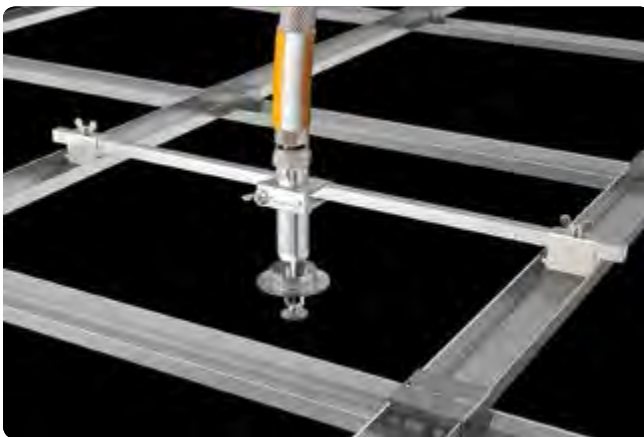

## Approvals/Listings:



## VicFlex™ Bracket for CD Profile

STYLE AB8

[Download submittal 10.85](#) for complete information

- One-piece bracket, for hard-lid ceilings
- Up to 10x faster than threaded black pipe, eliminate messy cutting tools
- Sizes 27½" | 700 mm and 55" | 1400 mm





## VicFlex™ Bracket for Armstrong™ TechZone™

STYLE AB10

[Download submittals 10.84 and 10.85](#) for complete information

- One-piece bracket, for Armstrong™ TechZone™ ceilings
- Eliminate messy cutting tools
- Sizes 6" | 150 mm

### Approvals/Listings:



## VicFlex™ for Surface Mount

STYLE AB3

[Download submittal 10.88](#) for complete information

- One-piece bracket, for institutional applications
- Up to 10x faster than threaded black pipe, eliminate messy cutting tools
- Reducer nipples sizes 5.75" | 140 mm, 9.0" | 230 mm, and 13" | 330 mm

### Approvals/Listings:

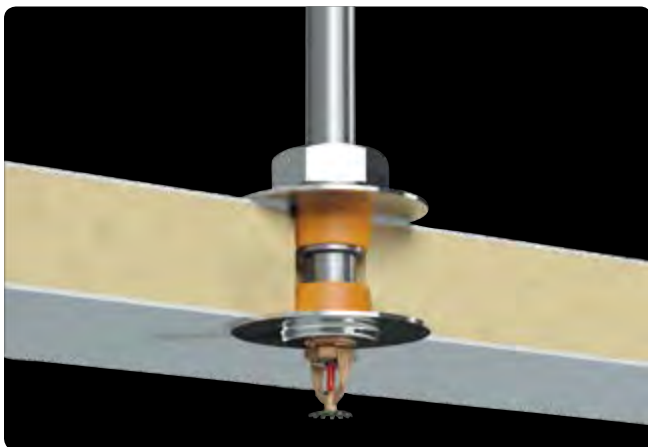

## VicFlex™ for Cold Storage

STYLE AB6

[Download submittal 10.90](#) for complete information

- Assembly components: V36 dry sprinkler, Series AH2 braided hose, bracket assembly
- Cold storage applications, eliminate condensation and combats differential movement
- Up to 4x faster than threaded black pipe, eliminate messy cutting tools and foam seals
- Sizes 31–72" | 790–1830 mm

### Approvals/Listings:



## VicFlex™ Sprinkler Fitting System



### Approvals/Listings:



## VicFlex™ for Duct

### SERIES AQD

[Download submittal 10.87](#) for complete information

- Fiberglass-reinforced plastic duct applications
- Square or round base mounts
- Minimum bend radius: FM – 6" | 150 mm
- Sizes 24–72" | 610–1830 mm
- Pressures up to 175 psi | 1207 kPa | 12 bar



### Approvals/Listings:



## VicFlex™ for Clean Rooms

### SERIES AQC

[Download submittal 10.86](#) for complete information

- Clean room applications
- Minimum bend radius: FM–6" | 150 mm
- Sizes 24–72" | 610–1830 mm
- Pressures up to 175 psi | 1207 kPa | 12 bar



### Approvals/Listings:



## VicFlex™ Reducer Nipples and Elbows

[Download submittals 10.84, 10.85, 10.88](#)  
and [10.89](#) for complete information

- Reducer nipples sizes 5.75" | 140 mm, 9.0" | 230 mm, and 13" | 330 mm
- Reducer 90° elbows sizes 4.8" | 123 mm and 6.3" | 161 mm

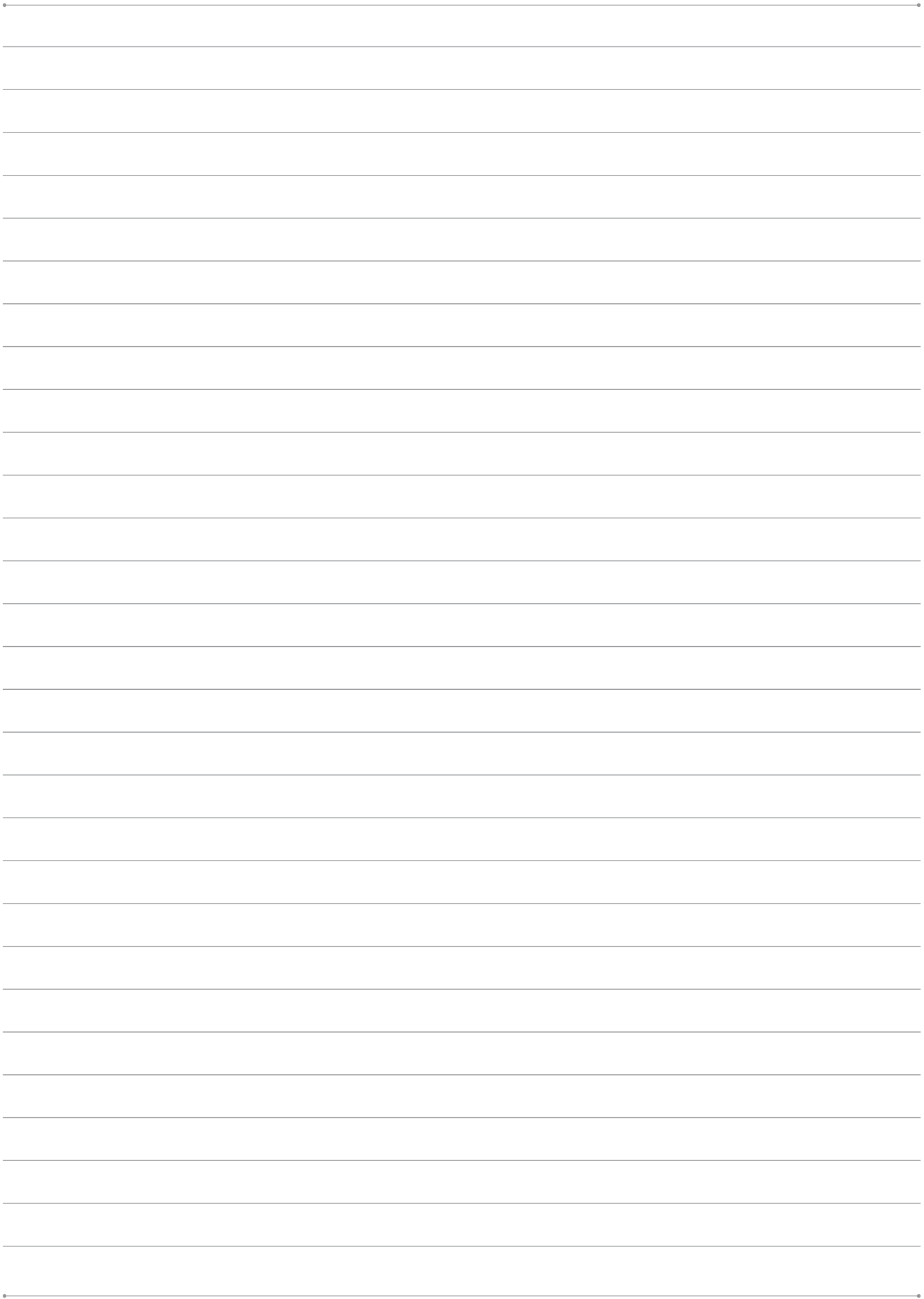





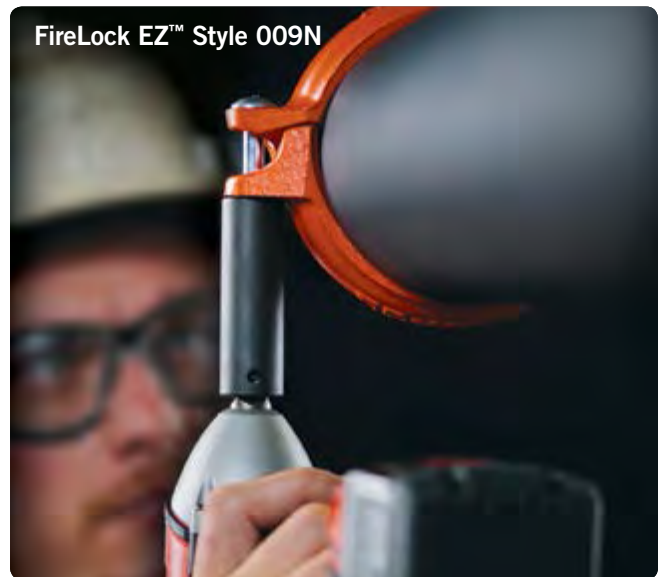

## Couplings

Victaulic®, the originator and innovator of grooved pipe joining technology, offers a wide variety of coupling styles and sizes for fire protection systems. In 1952, Victaulic developed the first UL Listed coupling and continues to build upon this legacy, providing products that facilitate fast and consistent installation. One key product development was the FireLock EZ™ Installation-Ready™ technology, eliminating the need to disassemble and reassemble components during installation.



Couplings	page	Adapters	page
 FireLock EZ Rigid Coupling (Style 009N)	11	 FireLock Flange Adapter (Style 744)	15
 FireLock™ Rigid Coupling (Style 005)	11	 Vic-Flange Adapter (Style 741)	15
 Zero-Flex™ Rigid Coupling (Style 07)	11	 Vic-Flange Adapter (Style 743)	16
 QuickVic™ Rigid Coupling (Style 107)	12		
 Standard Flexible Coupling (Style 77)	12		
 QuickVic Flexible Coupling (Style 177N)	12		
 Flexible Coupling (Style 75)	13		
 Reducing Coupling (Style 750)	13		
 AGS Flexible Coupling (Style W77)	13		
 Rigid Coupling for Type 316 Stainless Steel (Style 489)	14		
 Outlet Coupling (Style 72)	14		
 High Pressure Rigid Coupling (Style HP-70)	14		
 Vic-Boltless Coupling and Tool (Styles 791 and 792)	15		

## Couplings

Gasket Type	Style 009N	Style 005	Style 07	Style 107	Style 77	Style 177	Style 75	Style 750	Style W77	Style 489	Style 72 †	Style HP-70	Style 791
Standard 		•	•		•		•				•	•	•
Reducing 								•					
FlushSeal™ 		•	•		•		•		•				•
Installation-Ready™ 	•			•		•							

† Separate gasket specifically designed for outlet couplings.

### FireLock EZ™ Style 009N

**Installation-Ready means fast, dependable no-nonsense productivity**

Improved:

- 50% Reduced installation effort
- 100% Improved battery life

Continued:

- Fast, consistent installation
- Easy visual confirmation

As easy as it gets:

- No loose parts to drop or cause injury
- Ships ready to install
- 1¼–8" | 32–200 mm
- Pressures up to 365 psi | 2517 kPa | 25 bar

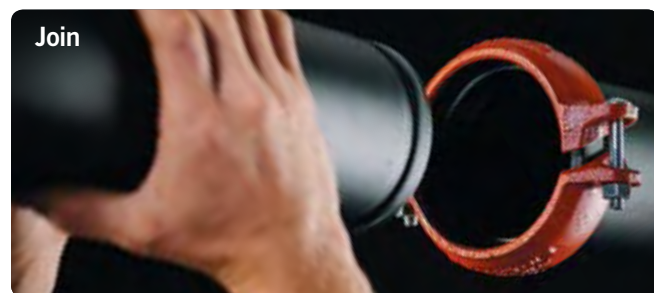

## Couplings

INSTALLATION-  
READY™

## FireLock EZ™ Rigid Coupling

STYLE 009N

[Download submittal 10.64](#) for complete information

- Angled bolt pad provides rigidity
- Sizes 1¼–8" | 32–200 mm
- Pressures up to 365 psi | 2517 kPa | 25 bar
- For coating options, download product submittal

## Approvals/Listings:



## FireLock™ Rigid Coupling

STYLE 005

[Download submittal 10.02](#) for complete information

- Angled bolt pad provides rigidity
- Sizes 1¼–8" | 32–200 mm
- Pressures up to 350 psi | 2413 kPa | 24 bar
- For coating options, download product submittal

## Approvals/Listings:



## Zero-Flex™ Rigid Coupling

STYLE 07

[Download submittal 06.02](#) for complete information

- Angled bolt pad provides rigidity
- Sizes 1–12" | 25–300 mm
- Pressures up to 500 psi | 3447 kPa | 34 bar
- For coating options, download product submittal

## Approvals/Listings:

[Download publication 10.01](#) for complete information

## Couplings

INSTALLATION-  
READY

## QuickVic™ Rigid Coupling

STYLE 107

[Download submittal 06.21](#) for complete information

- Angled bolt pad provides rigidity
- Sizes 2–12" | 50–300 mm
- Pressures up to 400 psi | 2758 kPa | 28 bar
- For coating options, download product submittal

## Approvals/Listings:

[Download publication 10.01](#) for complete information

## Flexible Coupling

STYLE 77

[Download submittal 06.04](#) for complete information

- Cross-ribbed housing construction
- Sizes ¾–24" | 20–600 mm
- Pressures up to 500 psi | 3447 kPa | 34 bar
- For coating options, download product submittal



## Approvals/Listings:

[Download publication 10.01](#) for complete information

## QuickVic™ Flexible Coupling

STYLE 177N

[Download submittal 06.24](#) for complete information

- Sizes 2–6" | 50–150 mm
- Pressures up to 840 psi | 5792 kPa | 58 bar
- For coating options, download product submittal

INSTALLATION-  
READY

## Approvals/Listings:

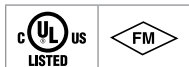
[Download publication 10.01](#) for complete information



## Couplings



### Approvals/Listings:



[Download publication 10.01](#) for complete information

## Flexible Coupling

### STYLE 75

[Download submittal 06.05](#) for complete information

- Lightweight coupling for moderate pressures
- Sizes 1–8" | 25–200 mm
- Pressures up to 500 psi | 3447 kPa | 34 bar
- For coating options, download product submittal



### Approvals/Listings:



[Download publication 10.01](#) for complete information

## Reducing Coupling

### STYLE 750

[Download submittal 06.08](#) for complete information

- Replaces two couplings and a reducing fitting
- Sizes 2–10" | 50–275 mm
- Pressures up to 360 psi | 2482 kPa | 25 bar
- For coating options, download product submittal



### Approvals/Listings:



[Download publication 10.01](#) for complete information

## AGS Flexible Coupling

### STYLE W77

[Download submittal 20.03](#) for complete information

- Unique wedge shaped key profile increases allowable pipe end separation
- Sizes 14–24" | 350–600 mm
- Pressures up to 350 psi | 2413 kPa | 24 bar
- For coating options, download product submittal



## Rigid Coupling for Type 316 Stainless Steel

STYLE 489

[Download submittal 17.25](#) for complete information

- Greatly reduces linear or angular movement and is useful for valve connections where rigidity is required
- Sizes 1½–12" | 40–300 mm
- Pressures up to 600 psi | 4137 kPa | 41 bar

### Approvals/Listings:



[Download publication 10.01](#) for complete information



## Outlet Coupling

STYLE 72

[Download submittal 06.10](#) for complete information

- Coupling with integral reducing outlet
- Sizes 1½–6" | 40–150 mm
- Pressures up to 500 psi | 3447 kPa | 34 bar
- For coating options, download product submittal

### Approvals/Listings:



[Download publication 10.01](#) for complete information



## High Pressure Rigid Coupling

STYLE HP-70

[Download submittal 06.12](#) for complete information

- Heavy housing for high pressure services
- Sizes 2–16" | 50–400 mm
- Pressures up to 750 psi | 5171 kPa | 52 bar
- For coating options, download product submittal

### Approvals/Listings:



[Download publication 10.01](#) for complete information

## Couplings



## Approvals/Listings:



[Download publication 10.01](#) for complete information

**Vic-Boltless Coupling and Tool**

STYLES 791 AND 792

[Download submittal 06.11](#) for complete information

- Provides a secure, tamper-resistant, low-profile joint
- Sizes 2–8" | 50–200 mm
- Pressures up to 350 psi | 2413 kPa | 24 bar
- For coating options, download product submittal



## Approvals/Listings:

**FireLock™ Flange Adapter**

STYLE 744

[Download submittal 10.04](#) for complete information

- ANSI Class 125 and 150 flanges
- Sizes 2–8" | 50–200 mm
- Pressures up to 175 psi | 1207 kPa | 12 bar
- For coating options, download product submittal
- Not available in Europe



## Approvals/Listings:



[Download publication 10.01](#) for complete information

**Vic-Flange Adapter**

STYLE 741

[Download submittal 06.06](#) for complete information

- ANSI Class 125 and 150 flanges
- Sizes 2–24" | 50–600 mm
- Pressures up to 290 psi | 1999 kPa | 20 bar
- For coating options, download product submittal



## Vic-Flange Adapter

STYLE 743

[Download submittal 06.06](#) for complete information

- ANSI Class 300 flanges
- Sizes 2–12" | 50–300 mm
- Pressures up to 500 psi | 3447 kPa | 34 bar
- For coating options, download product submittal
- Not available in Europe

### Approvals/Listings:



[Download publication 10.01](#) for complete information









## Fittings





Victaulic® FireLock™ full-flow elbows and tees feature CAD-developed, hydrodynamic design, affording a shorter center-to-end dimension than standard fittings. Victaulic innovation continues with the Vic™-End II No. 67 end of run elbow, the fast, easy and economical way to end a branch line.



### FireLock Fittings

	90° Elbow (No. 001)	17
	45° Elbow (No. 003)	17
	Straight Tee (No. 002)	17
	Cap (No. 006)	17
	Drain Elbow (No. 10-DR)	18
	Vic-End II End of Run Elbow (No. 67)	18

### Grooved End Standard Fittings

	90° Elbow (No. 10)	18
	45° Elbow (No. 11)	18
	Straight Tee (No. 20)	18
	Cap (No. 60)	18



### Approvals/Listings:



## FireLock™ Fittings

**NO. 001 90° ELBOW**  
**NO. 003 45° ELBOW**  
**NO. 002 STRAIGHT TEE**  
**NO. 006 CAP**

[Download submittal 10.03](#) for complete information

- *FireLock* full-flow elbows and tees feature CAD-developed, hydrodynamic design, affording a shorter center-to-end dimension than standard fittings
- Noticeable bulge allows the water to make a smoother turn to maintain similar flow characteristics as standard full flow fittings
- Fittings available from 1¼–8" | 32–200 mm
- For coating options, download product submittal



## Drain Elbow

NO. 10-DR

[Download submittal 10.05](#) for complete information

- Standard fitting pressure ratings conform to ratings of installed coupling
- All fittings supplied with grooves for fast installation
- Fittings available from 2½–6" | 65–150 mm
- For coating options, download product submittal

Approvals/Listings:



## Vic™-End II End of Run Elbow

NO. 67

[Download submittal 10.21](#) for complete information

- Standard fitting pressure ratings conform to ratings of installed coupling
- All fittings supplied with grooves for fast installation
- Fittings available from 1¼–2½" | 32–65 mm
- For coating options, download product submittal

Approvals/Listings:

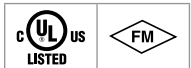

## Standard Grooved End Fittings

NO. 10 90° ELBOW  
 NO. 11 45° ELBOW  
 NO. 20 STRAIGHT TEE  
 NO. 60 CAP

[Download submittal 07.01](#) for complete information on original grooved end fittings for carbon steel pipe

- Standard fitting pressure ratings conform to ratings of installed coupling
- All fittings supplied with grooves for fast installation
- Fittings available from ¾–12" | 20–600 mm
- For coating options, download product submittal

Approvals/Listings:



[Download publication 10.01](#) for complete information

## Hole Cut Systems

Victaulic® developed the hole cut piping system concept to enable a fast and easy mid-pipe outlet solution that would not require welding. The system allows for a direct branch connection at any location where a hole can be cut in the pipe. Gaskets are molded to conform to the outer diameter of the pipe and are pressure responsive to provide a seal.

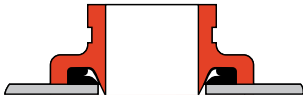

### Outlets

page

### Tools

page



FireLock™ Outlet-T (Style 922)

19



Hole Cutting Tools

73



FireLock Low-Profile Sprinkler Tee – EMEA only (Style 912)

20



Mechanical-T Outlet (Style 920/920N)

20



Strapless Outlet (Style 923)

20



## FireLock™ Outlet-T

STYLE 922

[Download submittal 10.52](#) for complete information

- Provides a direct branch connection at any location where a hole can be cut in the pipe
- Available as female threaded outlet
- Sizes from 1¼–2½" | 25–76.1 mm
- Pressures up to 300 psi | 2068 kPa | 21 bar
- For coating options, download product submittal

### Approvals/Listings:





## FireLock™ Low Profile Sprinkler Tee – EMEA only

STYLE 912

[Download submittal 10.53](#) for complete information

- Provides a direct branch connection for sprinklers only at any location where a hole can be cut in the pipe
- Sizes from 1 – 1½" | 25 – 40 mm
- Pressures up to 300 psi | 2068 kPa | 21 bar
- For coating options, download product submittal

**Approvals/Listings:**



## Mechanical-T Outlet

STYLE 920/920N

[Download submittal 11.02](#) for complete information

- Provides a direct branch connection at any location where a hole can be cut in the pipe
- Available as a tee or cross outlet with female threaded or grooved ends
- Sizes from 2 – 8" | 25 – 300 mm
- Pressures up to 400 psi | 2758 kPa | 28 bar
- Download product submittal for the following: coating options; standard thread options

**Approvals/Listings:**



[Download publication 10.01](#) for complete information



## Strapless Outlet

STYLE 923

[Download submittal 11.05](#) for complete information

- Provides a fast, easy pipe outlet without the need for a strap or lower housing
- Sizes from 4 – 12" | 100 – 300 mm
- Pressures up to 175 psi | 1207 kPa | 12 bar

**Approvals/Listings:**



[Download publication 10.01](#) for complete information



## Valves and Accessories

Since 1919 Victaulic® has been committed to innovation in the pursuit of faster and easier ways to join piping systems. Specifically within the Fire Protection industry Victaulic continues to simplify the installation process by reducing individual pieces and parts by engineering unique products that serve multiple functions and have smaller footprints. Evidence of this practice can be seen in the FireLock™ Commercial Zone Control Riser Module (Series 747M) and the Alarm Test Module.



<b>Valves</b>	<b>page</b>	<b>Valves</b>	<b>page</b>
<i>FireLock Butterfly Valve – Supervised Open (Series 705)</i>	22	<i>FireLock Ball Valve (Series 728)</i>	25
<i>FireLock High Pressure Butterfly Valve – Supervised Open (Series 765)</i>	22	<i>FireLock Ball Valve (Series 722)</i>	25
<i>FireLock Butterfly Valve – Supervised Closed (Series 707C)</i>	22	<i>FireLock Residential Zone Control Riser Module (Series 247)</i>	26
<i>FireLock High Pressure Butterfly Valve – Supervised Closed (Series 766)</i>	23	<i>FireLock Commercial Zone Control Riser Module (Series 747M)</i>	26
<i>FireLock Check Valve (Series 717)</i>	23	<b>Accessories</b> <span style="float: right;"><b>page</b></span>	
<i>FireLock High Pressure Check Valve (Series 717H)</i>	23	<i>FireLock Wall Post Indicator (Series 773)</i>	27
<i>FireLock Riser Check Valve (Series 717R)</i>	24	<i>FireLock Upright Post Indicator (Series 774)</i>	27
<i>FireLock Riser Check Valve (Series 717HR)</i>	24	<i>TestMaster™ II Alarm Test Module (Series 720)</i>	27
<i>FireLock OS&amp;Y Gate Valves (Series 771H/771F)</i>	24	<i>Fire Pump Test Meter (Series 735)</i>	28
<i>FireLock NRS Gate Valves (Series 772H/772F)</i>	25	<i>FireLock Wye Type Vic-Strainer (Series 732H)</i>	28



## FireLock™ Butterfly Valve – Supervised Open

SERIES 705

[Download submittal 10.81](#) for complete information

- Weatherproof actuator housing approved for indoor or outdoor use
- Ductile iron body and disc with EPDM seats
- Sizes from 2–12" | 50–300 mm
- Pressures up to 300 psi | 2068 kPa | 21 bar

Approvals/Listings:



## FireLock™ High Pressure Butterfly Valve – Supervised Open

SERIES 765

[Download submittal 10.80](#) for complete information

- Weatherproof actuator housing approved for indoor or outdoor use
- Ductile iron body and disc with nitrile seats
- Sizes from 2–12" | 50–300 mm
- Pressures up to 365 psi | 2517 kPa | 25 bar

Approvals/Listings:



## FireLock™ Butterfly Valve – Supervised Closed

SERIES 707C

[Download submittal 10.75](#) for complete information

- Design to be Supervised Closed during normal operating conditions
- Ductile iron body and disc with EPDM seats
- Sizes from 2–8" | 50–200 mm
- Pressures up to 300 psi | 2068 kPa | 21 bar

Approvals/Listings:



## Valves and Accessories



## Approvals/Listings:



## FireLock™ High Pressure Butterfly Valve – Supervised Closed

### SERIES 766

[Download submittal 10.83](#) for complete information

- Designed to be Supervised Closed during normal operating conditions
- Ductile iron body and disc with nitrile seats
- Sizes from 2–12" | 50–300 mm
- Pressures up to 365 psi | 2517 kPa | 25 bar



## Approvals/Listings:



## FireLock™ Check Valve

### SERIES 717

[Download submittal 10.08](#) for complete information

- Features an elastomer encapsulated disc with an electroless nickel plated seat
- Sizes from 2½–12" | 65–300 mm
- Pressures up to 365 psi | 2517 kPa | 25 bar



## Approvals/Listings:



## FireLock™ High Pressure Check Valve

### SERIES 717H

[Download submittal 10.08](#) for complete information

- Features a stainless steel disc which seats against the O-ring seal, when mounted on the electroless nickel plated face
- Sizes from 2–3" | 50–80 mm
- Pressures up to 365 psi | 2517 kPa | 25 bar



## FireLock™ Riser Check Valve

SERIES 717R

[Download submittal 10.09](#) for complete information

- Features an elastomer encapsulated disc with an electroless nickel plated seat
- Includes upstream and downstream pressure taps, must specify riser check kit when ordered
- Sizes from 4–8" | 100–200 mm
- Pressures up to 365 psi | 2517 kPa | 25 bar

### Approvals/Listings:



## FireLock™ High Pressure Riser Check Valve

SERIES 717HR

[Download submittal 10.09](#) for complete information

- Features a stainless steel disc which seats against the O-ring seal, when mounted on the electroless nickel plated face
- Includes upstream and downstream pressure taps, must specify riser check kit when ordered
- Sizes from 2–3" | 50–75 mm
- Pressures up to 365 psi | 2517 kPa | 25 bar

### Approvals/Listings:

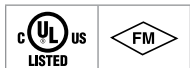

## FireLock™ OS&Y Gate Valves

SERIES 771H and 771F

[Download submittal 10.92](#) for complete information

- Available as Groove × Groove or Groove × Flange\*
- Used when positive shut-off is required in a fire line and a quick visual indicator of open/closed position is needed
- Sizes from 2½–12" | 65–300 mm
- Pressures up to 250 psi | 1724 kPa | 17 bar

\* Flange only available in ANSI

### Approvals/Listings:





## Valves and Accessories



### Approvals/Listings:



## FireLock™ NRS Gate Valves

SERIES 772H and 772F

[Download submittal 10.92](#) for complete information

- Available as Groove × Groove or Groove × Flange\*
  - Used for shut-off service where the valve is operated remotely
  - Sizes from 2½–12" | 65–300 mm
  - Pressures up to 250 psi | 1724 kPa | 17 bar
- \* Flange only available in ANSI



### Approvals/Listings:



## FireLock™ Ball Valve

SERIES 728

[Download submittal 10.17](#) for complete information

- Standard port and supervisory switch, available with grooved or female threaded ends
- Sizes from 1–2" | 25–50 mm
- Pressures up to 365 psi | 2517 kPa | 25 bar



### Approvals/Listings:



[Download publication 10.01](#) for complete information

## Brass Body Threaded Ball Valve

SERIES 722

[Download submittal 08.15](#) for complete information

- Standard port, female threaded end valve constructed from forged brass
- Sizes from ¼–2" | 8–50 mm
- Pressures up to 600 psi | 4137 kPa | 41 bar



Approvals/Listings:



## FireLock™ Residential Zone Control Riser Module

SERIES 247

[Download submittal 10.97](#) for complete information

- Features a cast body with shut off valve, test and drain valve combination and different sizes, flow switch, and a pressure gauge
- Sizes from 1–2" | 25–50 mm
- Pressures up to 365 psi | 2517 kPa | 25 bar



Approvals/Listings:



## FireLock™ Commercial Zone Control Riser Module

SERIES 747M

[Download submittal 10.96](#) for complete information

- Features a cast body with shut off valve, test and drain valve combination and different sizes, flow switch, and a pressure gauge
- Sizes from 1¼–6" | 32–150 mm
- Pressures up to 365 psi | 2517 kPa | 25 bar



## Approvals/Listings:



## FireLock™ Wall Post Indicator

SERIES 773

[Download submittal 10.92](#) for complete information

- For use with *FireLock* NRS gate valves, see pg. 25
- Sizes from 2½–12" | 65–300 mm



## Approvals/Listings:



## FireLock™ Upright Post Indicator

SERIES 774

[Download submittal 10.92](#) for complete information

- For use with *FireLock* NRS gate valves, see pg. 25
- Sizes from 2½–12" | 65–300 mm



## Approvals/Listings:



## TestMaster™ II Alarm Test Module

SERIES 720

[Download submittal 10.22](#) for complete information

- Available with grooved or female threaded ends, and pressure relief valve
- Sizes from 1–2" | 25–50 mm
- Pressures up to 300 psi | 2068 kPa | 21 bar

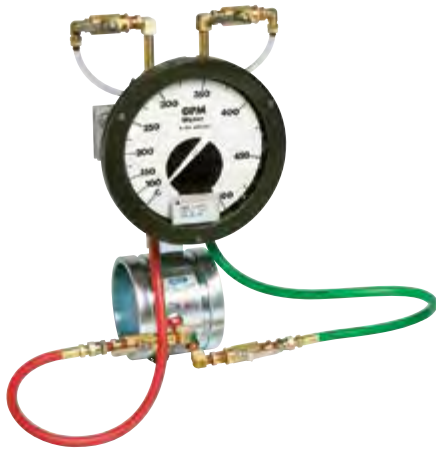

## Fire Pump Test Meter

SERIES 735

[Download submittal 10.11](#) for complete information

- Sizes from 1–2" | 25–50 mm
- Model “L” Pressure rated up to 175 psi | 1207 kPa | 12 bar
- Model “S” Pressure rated up to 500 psi | 3447 kPa | 34 bar

Approvals/Listings:



## FireLock™ Wye Type Vic-Strainer

SERIES 732H

[Download submittal 10.68](#) for complete information

- Provides straight through flow for lower pressure drop
- Sizes from 2–4" | 50–100 mm
- Pressures up to 365 psi | 2517 kPa | 25 bar
- For coating options, download product submittal

Approvals/Listings:

























## Devices and Accessories

FireLock NXT™ devices offer another leap forward in valve design and operation. Featuring a lower operating pressure and ultra-fast trip time, due to the elimination of the air-to-water differential, *FireLock NXT* devices deliver greater operational dependability and are easier to install, service and maintain. In addition, the compact trim and diaphragm design reduces the valve's center-to-back take out distance up to a full 7" | 178 mm when compared with competitive valves.



Devices	page	Accessories	page
 <i>FireLock NXT</i> Dry System Check Valve (Series 768)	31	 Air Maintenance/Compressor Assembly (Series 7C7)	35
 <i>FireLock NXT</i> Deluge System Check Valve (Series 769)	31	 <i>FireLock</i> 300 PSI Solenoid (Series 753-E)	35
 <i>FireLock NXT</i> Preaction System Check Valve (Series 769)	31	 Electronic/Pneumatic Double Interlock Actuator (Series 767)	35
 <i>FireLock NXT</i> Preaction System with AutoConvert Assembly (Series 769)	32	 Low Pressure Actuator (Series 776)	36
 <i>FireLock NXT</i> Alternate Wet/Dry System Check Valve – Europe Only (Series 764)	32	 Double Pneumatic Actuator (Series 798)	36
 FireLock™ Alarm Check Valve (Series 751)	32	 <i>FireLock</i> Ball Check Valve (Series 748)	36
 <i>FireLock</i> European Alarm Check Valve Station (Series 751)	33	 <i>FireLock</i> Auto Drain (Series 749)	37
 <i>FireLock Fire-Pac</i> (Series 745)	33	 Manual Release Panel (Series 755)	37
		 <i>FireLock</i> Dry Accelerator (Series 746-LPA)	37
		 <i>FireLock</i> Retard Chamber (Series 752)	38
		 <i>FireLock</i> Air Maintenance Trim Assembly (Series 757 and 757P)	38
		 Water Column Drain Kit (Series 75D)	38
		 Supplemental Alarm Kit (Series 75B)	39
		Water Motor Alarm (Series 760)	39

## Devices and Accessories

The innovative design of the new FireLock NXT™ line went beyond the valve itself. To reduce the footprint required for the trim to the bare minimum, trim components were redesigned to optimize performance and save space.

### EPS45-2V Supervisory Pressure Switch

Preset to activate between  
10–22 psi |  
69–152 kPa |  
0.69–1.52 bar

Saves 1 to 2 hours  
of installation time

No special tools required

### Air Feed Manifold

Redundant air path increases system safety  
Increased ease-of-maintenance  
Compact design reduces trim footprint

### Low Pressure Actuator

Single set point of 13 psi | 90 kPa | 0.9 bar for water  
supply systems up to 300 psi | 2068 kPa | 21 bar

Elimination of air-to-water differential prevents  
false trips during pressure surges

Allows use of smaller compressors — saves money

Faster water delivery to sprinklers

### Robust Diaphragm

Fewer moving parts  
Reduced weight and maintenance  
Straight-through valve design  
allows ultra-fast water delivery

### Valve Clapper Seal Design

Clapper rotates completely out  
of valve body for access

Easiest design in the industry  
for access and maintenance

No need to remove clapper to  
inspect or replace seal

Clapper closes when control valve  
is closed and main drain is above  
the clapper — keeps debris from  
gathering on seat, seal or entering  
intermediate chamber

### 3-in-1 Device

Increased ease of maintenance  
Single point of access to clean  
check valve, strainer and  
restricted orifice — no need  
to disassemble trim  
Reduced trim footprint





## FireLock NXT™ Dry System Check Valve

SERIES 768

[Download submittal 30.80](#) for complete information

- Available bare, pretrimmed, as a *Vic-Quick* riser or in a Series 745 *FireLock™ Fire-Pac* cabinet
- Sizes from 1½–8" | 40–200 mm
- Pressures up to 300 psi | 2068 kPa | 21 bar

### Approvals/Listings:



## FireLock NXT™ Deluge System Check Valve

SERIES 769

[Download submittal 30.81](#) for complete information

- Available bare, pretrimmed, as a *Vic-Quick* riser or in a Series 745 *FireLock™ Fire-Pac* cabinet
- Sizes from 1½–8" | 40–200 mm
- Pressures up to 300 psi | 2068 kPa | 21 bar

### Approvals/Listings:



## FireLock NXT™ Preaction System Check Valve

SERIES 769

[Download submittal 30.82](#) for complete information

- Available bare, pretrimmed, as a *Vic-Quick* riser or in a Series 745 *FireLock™ Fire-Pac* cabinet
- Sizes from 1½–8" | 40–200 mm
- Pressures up to 300 psi | 2068 kPa | 21 bar

### Approvals/Listings:





Approvals/Listings:



## FireLock NXT™ Preaction System with AutoConvert Assembly

SERIES 769

[Download submittal 30.84](#) for complete information

- Available bare, pretrimmed, as a *Vic-Quick* riser or in a Series 745 FireLock™ *Fire-Pac* cabinet
- Sizes from 1½–8" | 40–200 mm
- Pressures up to 300 psi | 2068 kPa | 21 bar



Approvals/Listings:



## FireLock NXT™ Alternate Wet/Dry System Check Valve – Europe Only

SERIES 764

[Download submittal 30.83](#) for complete information

- Available bare, pretrimmed, or as a *Vic-Quick* riser
- Sizes from 1½–8" | 40–200 mm
- Pressures up to 300 psi | 2068 kPa | 21 bar



## FireLock™ Alarm Check Valve

SERIES 751

[Download submittal 30.01](#) for complete information

- Prevents the reverse flow of water from the system piping to the water supply
- Sizes from 1½–8" | 40–200 mm
- Pressures up to 300 psi | 2068 kPa | 21 bar

Approvals/Listings:

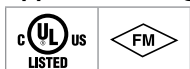



## Devices and Accessories



### Approvals/Listings:



## FireLock™ European Alarm Check Valve Station

SERIES 751

[Download submittal 30.01](#) for complete information

- Prevents the reverse flow of water from the system piping to the water supply
- Sizes from 1½–8" | 40–200 mm
- Pressures up to 300 psi | 2068 kPa | 21 bar



### Approvals/Listings:

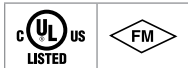

## FireLock™ Fire-Pac

SERIES 745

[Download submittal 30.23](#) for complete information

- Completely preassembled fire protection valve enclosed in weatherproof cabinet
- Sizes from 1½–8" | 40–200 mm
- Pressures up to 300 psi | 2068 kPa | 21 bar



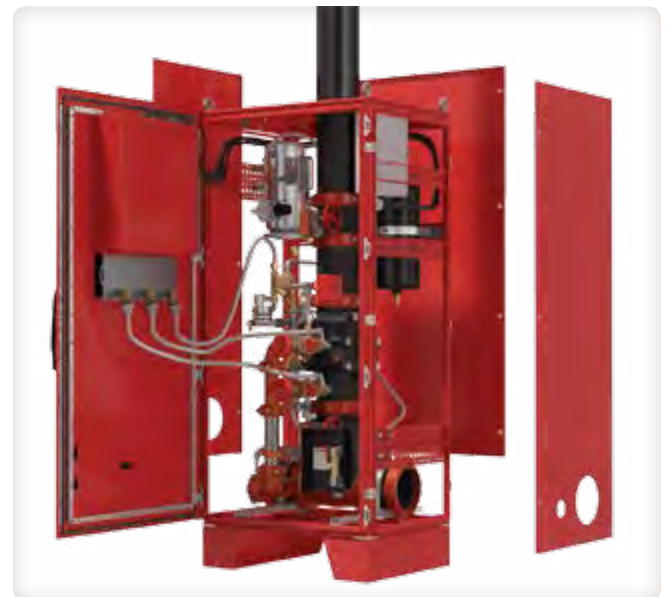

### Customized Solutions

With more options available than ever before each Fire-Pac System is completely unique.

- Weatherproofing to NEMA 4 standards
- Pipe feed and drain can be located on the left, right or bottom panels
- Insulation and heating components available down to a minimum ambient temperature of 20°F | -6°C
- Compressor and nitrogen fill kit options
- Panel design options now including an addressable panel capable of networking with other intelligent devices
- Special cabinet color option

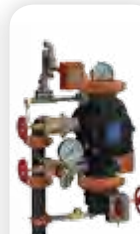

# Accessories Compatibility Chart

	 Series 768 Dry	 Series 769 Deluge	 Series 769 Preaction	 Series 764 Alternate Wet/Dry	 Series 751 Alarm Series 751 European Alarm Check Valve Station
<b>STANDARD</b>					
Series 7C7 Compressor Package	•	•	•	•	
Series 753-E Solenoid Actuator		•	•		
Series 767 Electric/Pneumatic Actuator			•		
Series 776 Low Pressure Actuator	•	•	•	•	
Series 798 Double Pneumatic Actuator			•		
Series 729 Ball Drip Assembly	•	•	•	•	
Series 748 Ball Check Valve	•	•	•	•	
Series 749 Auto Drain Assembly	•	•	•	•	
Series 755 Manual Pull Station		•	•		
<b>OPTIONAL</b>					
Series 746 Dry Accelerator	•	•	•	•	
Series 746-LPA Dry Accelerator	•	•	•	•	
Series 752 FireLock™ Retard Chamber					•
Series 757/757P Air Maintenance Trim Assembly	•	•	•	•	
Series 75-D Water Column Component Drain Kit	•	•	•	•	
Series 75-B Supplemental Alarm Kit	•	•	•	•	
Series 760 Water Motor Alarm	•	•	•	•	•
Drain Connection Kit	•	•	•	•	•
AutoConvert Trim Assembly			•		
<b>ELECTRICAL</b>					
Alarm Pressure Switches	•	•	•	•	•
Supervisory Switches	•	•	•	•	

- Intro
- VicFlex™
- Couplings
- Fittings
- Hole Cut
- Valves and Accessories
- Devices and Accessories**
- Automatic Sprinklers
- Victaulic Vortex™
- Specialty Systems
- Pipe Preparation Tools
- Design Data
- Index

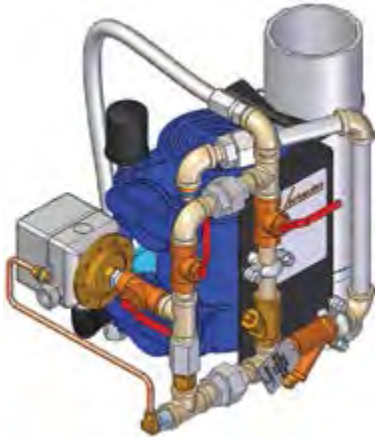

## Approvals/Listings:



## Air Maintenance/ Compressor Assembly

SERIES 7C7

[Download submittal 30.22](#) for complete information

- Features riser mounted compressor, Series 757P air maintenance device, and flexible hoses for installation



## Approvals/Listings:



## FireLock™ 300 PSI Solenoid

SERIES 753-E

[Download submittal 30.63](#) for complete information

- Designed for use with Victaulic® FireLock deluge and preaction devices that use electric actuation
- Uses a ½" | 15 mm NPT connection, wired for 24 VDC
- Pressures up to 300 psi | 2068 kPa | 21 bar



## Approvals/Listings:

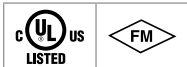

## Electric/Pneumatic Double Interlock Actuator

SERIES 767

[Download submittal 30.62](#) for complete information

- Designed for a single trip point for the pneumatic event, regardless of water supply pressure, and an integral electric solenoid
- Uses a ½" | 15 mm NPT connection, wired for 24 VDC
- Pressures up to 300 psi | 2068 kPa | 21 bar

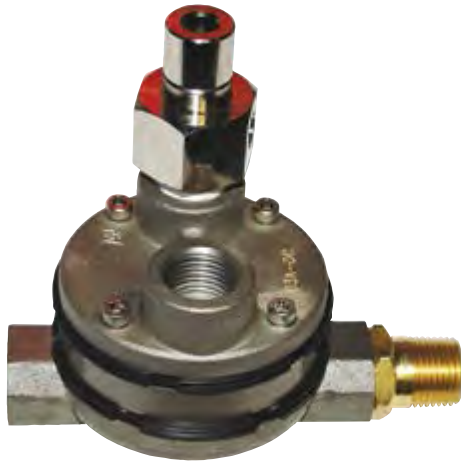

## Low Pressure Actuator

SERIES 776

[Download submittal 30.65](#) for complete information

- Designed for a single trip point for the pneumatic event, regardless of water supply pressure
- Comes standard on Series 768 dry, Series 769 deluge and Series 769 preaction FireLock NXT™ valves
- Pressures up to 300 psi | 2068 kPa | 21 bar

Approvals/Listings:



## Double Pneumatic Actuator

SERIES 798

[Download submittal 30.61](#) for complete information

- Designed to actuate at 7 psi | 48 kPa | 0.5 bar for both the pilot and sprinkler system
- Pressures up to 300 psi | 2068 kPa | 21 bar

Approvals/Listings:



## FireLock™ Ball Check Valve

SERIES 748

[Download submittal 30.44](#) for complete information

- Remains fully open allowing free flow of air until the sprinkler control valve is activated, at which time the flow of water entering the sprinkler system will close the ball check keeping the air supply trim from flooding
- Pressures up to 300 psi | 2068 kPa | 21 bar

Approvals/Listings:





## Devices and Accessories



### FireLock™ Auto Drain

SERIES 749

[Download submittal 30.43](#) for complete information

- Drains the diaphragm charge line, preventing the diaphragm from repressurizing
- Must manually reset after decay
- Pressures up to 300 psi | 2068 kPa | 21 bar

#### Approvals/Listings:



### Manual Release Panel

SERIES 755

[Download submittal 30.41](#) for complete information

- Operates as a manually operated actuating device
- Contains a special quarter turn ball valve mounted in a painted steel enclosure
- Pressures up to 300 psi | 2068 kPa | 21 bar



### FireLock™ Dry Accelerator

SERIES 746-LPA

[Download submittal 30.64](#) for complete information

- Designed for Series 768 dry and Series 769 preaction valves in order to speed response time and/or accommodate larger system
- System air pressures ranging from 13 psi | 90 kPa | 0.9 bar to 18 psi | 124 kPa | 1.2 bar
- Pressures up to 300 psi | 2068 kPa | 21 bar

#### Approvals/Listings:

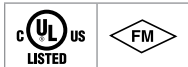



## FireLock™ Retard Chamber

SERIES 752

[Download submittal 30.31](#) for complete information

- Reduces the possibility of false alarms due to water supply pressure surges
- Designed for use with Victaulic® Series 751 alarm check valves
- Pressures up to 300 psi | 2068 kPa | 21 bar

Approvals/Listings:

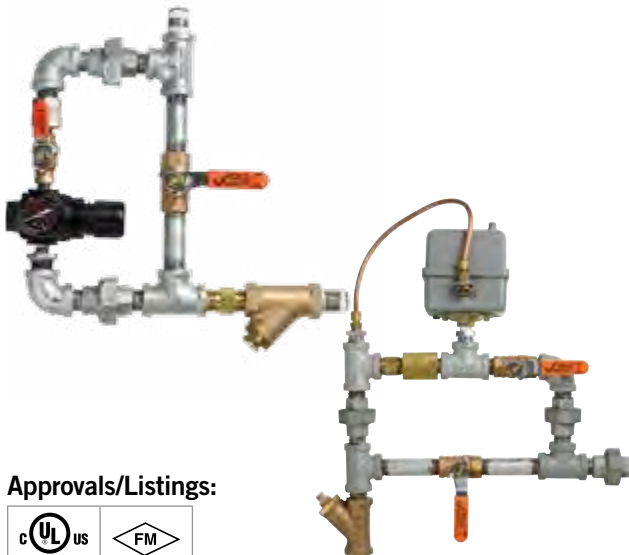

## FireLock™ Air Maintenance Trim Assembly

SERIES 757 and 757P

[Download submittal 30.35](#) and [30.36](#) for complete information

- Reduces high pressure supply air through the integral regulator to recommended air pressure based on the water supply pressure
- Series 757P designed with pressure switch for use with small compressors which do not have pressure control switches

Approvals/Listings:

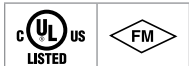

## Water Column Drain Kit

SERIES 75D

[Download submittal 30.34](#) for complete information

- Automatically drains residual water in the riser above the clapper
- No operator maintenance or resetting is required
- Pressures up to 175 psi | 1207 kPa | 12 bar

Approvals/Listings:





## Supplemental Alarm Kit

SERIES 75B

[Download submittal 30.33](#) for complete information

- Ensures that the mechanical alarm continues even if the clapper closes and water fills above it in the system
- Pressures up to 300 psi | 2068 kPa | 21 bar

### Approvals/Listings:



## Water Motor Alarm

SERIES 760

[Download submittal 30.32](#) for complete information

- Mechanical, water-powered device signaling the flow of water in an automatic sprinkler system
- For wall thicknesses 2–13" | 51–330 mm
- Red enamel is standard finish for the gong shell

### Approvals/Listings:







## Automatic Sprinklers









Victaulic® FireLock™ sprinklers are designed for a wide variety of applications and are available with a wide range of finishes and temperature ratings, aesthetic and performance requirements.

Victaulic offers a complete line of accessories, guards, shields, escutcheons, expansion and cover plates – all designed to provide you with a single source for your next sprinkler project.



### Category

### page

	Standard Commercial	43–44
	Extended Coverage	45–46
	Storage	47–48
	Residential	49
	Specific Application	50
	Dry	51–52
	Nozzles	53
	Wrenches	54
	Accessories	54

## Victaulic® FireLock™ Sprinklers

### Easy and Safe Installation

Open-end, socket-style and recessed sprinkler wrenches are designed specifically for installing Victaulic sprinklers.

### Innovative Design

New V3102 and V3104 sprinkler models offer extended spray coverage with an aesthetically pleasing flat cover plate.

### Proprietary Coatings

VC-250 is an optional, corrosion-resistant coating developed by Victaulic to increase the protection of *FireLock* sprinklers from visual and physical changes such as exposure to weather or exposure to areas that may be specified as chemical environments. When applied, this nickel based, multi-layer coating fully encompasses each *FireLock* sprinkler to provide increased corrosion resistance while maintaining functionality.

Available Temperature Ratings Table

Victaulic® Part Identification	Temperature – °F   °C		Sprinkler Temperature Classification	Glass Bulb Color	Solder Link Color
	Nominal Temp. Rating	Max. Ambient Temp. Allowed			
A <sup>1</sup>	135	100	Ordinary	Orange	
	57	38			
C	155			Red	
	68				
D <sup>2</sup>	165	100	Ordinary		
	74	38			
E	175	150	Intermediate	Yellow	
	79	65			
F	200	150	Intermediate	Green	
	93	65			
G	212	150	Intermediate		Black with White Dot/White Arms
	100	65			
J	286	225	High	Blue	Black with Blue Dot/Blue Arms
	141	107			
K	360	300	Extra High <sup>1</sup>	Purple	
	182	149			
M	Open		<sup>1</sup>	Open	Open
N	162	100	Ordinary		Black
	72	38			

<sup>1</sup> Standard response only.

<sup>2</sup> Cover for use with a Standard or Quick Response Concealed Sprinkler 175°F | 79°C or 200°F | 93°C

<sup>3</sup> 138°F | 59°C per LPCB

**Important Notes:**

All glass bulbs are rated for temperatures from -67° F | -55° C up to those shown in adjacent table.

Not all temperatures are available with all styles of sprinklers. Consult individual submittal sheet for specific information.

## Standard Commercial

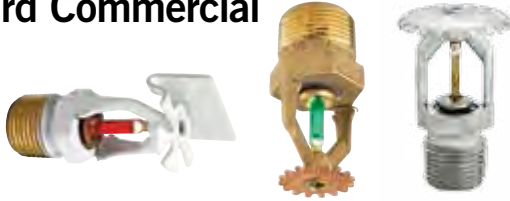

Note: Sprinkler approvals and listings can vary by model, temperature and finish. For complete regulatory information, consult the product submittal publication.

## Standard Response

Model/ SIN	K-Factor Imp.   S.I.	Hazard	Type	Response	Thread Size In.(NPT)   mm	Temperature Rating F   C (see below)	Approvals	Sprinkler Finish	Max. Pressure PSI   Bar	Wrench	Submittal
V2401	4.2 6.1	LH, OH	Upright	SR	3/8 10	135, 155, 175, 200, 286	cULus	B, CH, WH, BL, C, N, VC-250	181 12.5	V27, V27-2	<a href="#">40.87</a>
V2403	4.2 6.1	LH, OH	Pendent	SR	3/8 10	135, 155, 175, 200, 286	cULus	B, CH, WH, BL, C, N, VC-250	181 12.5	V27, V27-2	<a href="#">40.87</a>
V2701	2.8 4.0	LH, OH	European Upright	SR	1/2 15	135, 155, 175, 200, 286, 360	cULus, FM	B, CH, WH, BL, C, N, VC-250	175 12	V27, V27-2	<a href="#">40.40</a>
V2703	5.6 8.1	All	Upright	SR	1/2 15	135, 155, 175, 200, 286, 360	cULus, FM, VdS, LPCB, CNBOP, CCC, GOST	B, CH, WH, BL, C, N, VC-250, W	250 17	V27, V27-2	<a href="#">40.10</a>
V2705	2.8 4.0	LH, OH	Pendent	SR	1/2 15	135, 155, 175, 200, 286, 360	cULus	B, CH, WH, BL, C, N, VC-250	175 12	V27, V27-2	<a href="#">40.40</a>
V2707	5.6 8.1	All	Pendent	SR	1/2 15	135, 155, 175, 200, 286, 360	cULus, FM, LPCB, CCC, GOST	B, CH, WH, BL, C, N, VC-250, W	250 17	V27, V27-2	<a href="#">40.10</a>
V2709	5.6 8.1	All	Horizontal Sidewall	SR	1/2 15	135, 155, 175, 200, 286, 360	cULus, FM, LPCB, CCC, GOST	B, CH, WH, BL, C, N, VC-250, W	250 17	V27, V27-2	<a href="#">40.11</a>
V2725	5.6 8.1	OH	Conven- tional	SR	1/2 15	135, 155, 175, 200, 286, 360	cULus, VdS, LPCB	B, CH, WH, N, VC-250, W	175 12	V27, V27-2	<a href="#">40.17</a>
V2727	5.6 8.1	All	European Pendent	SR	1/2 15	135, 155, 175, 200, 286, 360	cULus, VdS, LPCB, CNBOP	B, CH, WH, N, VC-250	181 12.5	V27, V27-2	<a href="#">40.18</a>
V2753	5.6 8.1	OH	Conven- tional	SR	1/2 15	135, 155, 175, 200, 286, 360	cULus	B, N, VC-250	300 21	V27, V27-2	<a href="#">40.27</a>
V3401	8.0 11.5	All	Upright	SR	3/4 20	135, 155, 175, 200, 286, 360	cULus, FM, LPCB	B, CH, WH, BL, C, N, VC-250, W	175 12	V34	<a href="#">40.15</a>
V3405	8.0 11.5	All	Pendent	SR	3/4 20	135, 155, 175, 200, 286, 360	cULus, FM, GOST	B, CH, WH, BL, C, N, VC-250, W	175 12	V34	<a href="#">40.15</a>
V3409	8.0 11.5	All	Horizontal Sidewall	SR	3/4 20	135, 155, 175, 200, 286, 360	cULus, GOST	B, CH, WH, BL, C, N, VC-250, W	175 12	V34	<a href="#">40.16</a>
V3423	8.0 11.5	All	European Pendent	SR	3/4 20	135, 155, 175, 200, 286, 360	VdS, LPCB, CNBOP	B, CH, WH, C, N, VC-250	181 12.5	V34	<a href="#">40.19</a>
V3801	5.6 8.1	LH, OH	Concealed Pendent	SR	1/2 15	135, 155, 175, 200	cULus, LPCB, CCC, GOST	B, CH, WH, BL, C	300 21	V38-4, V38-5	<a href="#">40.50</a>
V3807	5.6 8.1	LH, OH	Concealed Pendent	SR	1/2 15	135, 155, 175, 200	cULus	B, CH, WH, BL, C	300 21	V38-4, V38-5	<a href="#">40.55</a>

Hazard Type		Response Type		Temperature Rating		Sprinkler Finishes	
Light Hazard	LH	Standard Response	SR	135°F	57°C	Plain Brass	B
Ordinary Hazard	OH	Quick Response	QR	155°F	68°C	Chrome plated	CH
LH, OH, Extra and Storage	All	Fast Response	FR	175°F	79°C	White painted	WH
Residential	Res	Open	Open	200°F	93°C	Black painted	BL
Specific Application	Spec			286°F	141°C	Custom	C
				360°F	182°C	Nickel Teflon™	N
						VC-250	VC-250
						Wax	W

# Standard Commercial

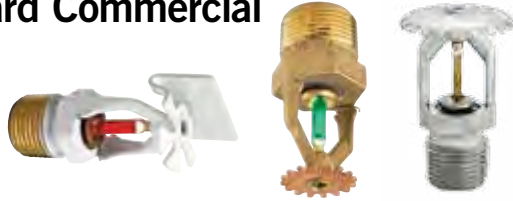

Note: Sprinkler approvals and listings can vary by model, temperature and finish. For complete regulatory information, consult the product submittal publication.

Quick Response											
Model/SIN	K-Factor Imp.   S.I.	Hazard	Type	Response	Thread Size In.(NPT)   mm	Temperature Rating F   C	Approvals	Sprinkler Finish	Max. Pressure PSI   Bar	Wrench	Submittal
V2402	4.2 6.1	LH, OH	Upright	QR	3/8 10	135, 155, 175, 200, 286	cULus	B, CH, WH, BL, C, N, VC-250	181 12.5	V27, V27-2	<a href="#">40.87</a>
V2404	4.2 6.1	LH, OH	Pendent	QR	3/8 10	135, 155, 175, 200, 286	cULus	B, CH, WH, BL, C, N, VC-250	181 12.5	V27, V27-2	<a href="#">40.87</a>
V2702	2.8 4.0	LH, OH	European Upright	QR	1/2 15	135, 155, 175, 200, 286	cULus, FM	B, CH, WH, BL, C, N, VC-250	175 12	V27, V27-2	<a href="#">40.40</a>
V2704	5.6 8.1	All	Upright	QR	1/2 15	135, 155, 175, 200, 286	cULus, FM, VdS, LPCB, CNBOP, CCC, GOST	B, CH, WH, BL, C, N, VC-250	250 17	V27, V27-2	<a href="#">40.10</a>
V2706	2.8 4.0	LH, OH	Pendent	QR	1/2 15	135, 155, 175, 200, 286	cULus	B, CH, WH, BL, C, N, VC-250	175 12	V27, V27-2	<a href="#">40.40</a>
V2708	5.6 8.1	All	Pendent	QR	1/2 15	135, 155, 175, 200, 286	cULus, FM, CCC, GOST	B, CH, WH, BL, C, N, VC-250	250 17	V27, V27-2	<a href="#">40.10</a>
V2710	5.6 8.1	All	Horizontal Sidewall	QR	1/2 15	135, 155, 175, 200, 286,	cULus, FM, LPCB, GOST	B, CH, WH, BL, C, N, VC-250, W	250 17	V27, V27-2	<a href="#">40.11</a>
V2726	5.6 8.1	OH	Conventional	QR	1/2 15	135, 155, 175, 200, 286	cULus, VdS, LPCB	B, CH, WH, N, VC-250, W	175 12	V27, V27-2	<a href="#">40.17</a>
V2728	5.6 8.1	All	European Pendent	QR	1/2 15	135, 155, 175, 200, 286	cULus, VdS, LPCB, CNBOP	B, CH, WH, N, VC-250	181 12.5	V27, V27-2	<a href="#">40.18</a>
V2754	5.6 8.1	OH	Conventional	QR	1/2 15	135, 155, 175, 200, 286, 360	cULus	B, N, VC-250	300 21	V27, V27-2	<a href="#">40.27</a>
V3402	8.0 11.5	All	Upright	QR	3/4 20	135, 155, 175, 200, 286	cULus, FM, LPCB	B, CH, WH, BL, C, N, VC-250, W	175 12	V34	<a href="#">40.15</a>
V3406	8.0 11.5	All	Recessed Pendent	QR	3/4 20	135, 155, 175, 200	cULus, FM, GOST	B, CH, WH, BL, C, N, VC-250, W	175 12	V34	<a href="#">40.15</a>
V3410	8.0 11.5	All	Horizontal Sidewall	QR	3/4 20	135, 155, 175, 200, 286	cULus, GOST	B, CH, WH, BL, C, N, VC-250, W	175 12	V34	<a href="#">40.16</a>
V3424	8.0 11.5	All	European Pendent	QR	3/4 20	135, 155, 175, 200, 286	VdS, LPCB, CNBOP	B, CH, WH, C, N, VC-250	181 12.5	V34	<a href="#">40.19</a>
V3802	5.6 8.1	LH, OH	Concealed Pendent	QR	1/2 15	135, 155, 175, 200	cULus, FM, LPCB, GOST	B, CH, WH, BL, C	175 12	V38-4, V38-5	<a href="#">40.50</a>
V3808	5.6 8.1	LH, OH	Concealed Pendent	QR	1/2 15	135, 155, 175, 200	cULus	B, CH, WH, BL, C	300 21	V38-4, V38-5	<a href="#">40.55</a>

Hazard Type		Response Type		Temperature Rating		Sprinkler Finishes	
Light Hazard	LH	Standard Response	SR	135°F	57°C	Plain Brass	B
Ordinary Hazard	OH	Quick Response	QR	155°F	68°C	Chrome plated	CH
LH, OH, Extra and Storage	All	Fast Response	FR	175°F	79°C	White painted	WH
Residential	Res	Open	Open	200°F	93°C	Black painted	BL
Specific Application	Spec			286°F	141°C	Custom	C
				360°F	182°C	Nickel Teflon™	N
						VC-250	VC-250
						Wax	W

## Extended Coverage



Note: Sprinkler approvals and listings can vary by model, temperature and finish. For complete regulatory information, consult the product submittal publication.

Standard Response											
Model/ SIN	K-Factor Imp.   S.I.	Hazard	Type	Response	Thread Size In.(NPT)   mm	Temperature Rating F   C	Approvals	Sprinkler Finish	Max. Pressure PSI   Bar	Wrench	Submittal
V3411	11.2 16.1	LH	Pendent	SR	¾ 20	135, 155, 175, 200	cULus, FM	B, CH, WH, BL, C, N, VC-250	175 12	V34	<a href="#">40.30</a>
V3413	14.0 20.2	LH	Pendent	SR	¾ 20	135, 155, 175, 200	cULus, FM	B, CH, WH, BL, C, N, VC-250	175 12	V34	<a href="#">40.31</a>
V3415	8.0 11.5	LH	Horizontal Sidewall	SR	¾ 20	135, 155, 175, 200	cULus, FM	B, CH, WH, BL, C, N, VC-250	175 12	V34	<a href="#">40.33</a>
V3421	14.0 20.2	OH	Pendent	SR	¾ 20	155, 175, 200, 286	cULus	B, CH, WH, BL, C, VC-250	175 12	V34	<a href="#">40.34</a>
V3425	14.0 20.2	OH	Upright	SR	¾ 20	155, 175, 200, 286	cULus	B, CH, WH, BL, C, VC-250	175 12	V34	<a href="#">40.34</a>

Hazard Type		Response Type		Temperature Rating		Sprinkler Finishes	
Light Hazard	LH	Standard Response	SR	135°F	57°C	Plain Brass	B
Ordinary Hazard	OH	Quick Response	QR	155°F	68°C	Chrome plated	CH
LH, OH, Extra and Storage	All	Fast Response	FR	175°F	79°C	White painted	WH
Residential	Res	Open	Open	200°F	93°C	Black painted	BL
Specific Application	Spec			286°F	141°C	Custom	C
				360°F	182°C	Nickel Teflon™	N
						VC-250	VC-250
						Wax	W



# Extended Coverage



Note: Sprinkler approvals and listings can vary by model, temperature and finish. For complete regulatory information, consult the product submittal publication.

Quick Response											
Model/SIN	K-Factor Imp.   S.I.	Hazard	Type	Response	Thread Size In.(NPT)   mm	Temperature Rating F   C	Approvals	Sprinkler Finish	Max. Pressure PSI   Bar	Wrench	Submittal
V3102	8.0 11.2	LH	Concealed Pendent	QR	¾ 20	135	cULus	B, CH, WH, BL, C	175 12	V31, V33	<a href="#">40.76</a>
V3104	11.2 16.1	LH	Concealed Pendent	QR	¾ 20	135	cULus	B, CH, WH, BL, C	175 12	V31, V33	<a href="#">40.76</a>
V3412	11.2 16.1	LH	Pendent	QR	¾ 20	135, 155, 175, 200	cULus, FM	B, CH, WH, BL, C, N, VC-250	175 12	V34	<a href="#">40.30</a>
V3414	14.0 20.2	LH	Pendent	QR	¾ 20	135, 155, 175, 200	cULus, FM	B, CH, WH, BL, C, N, VC-250	175 12	V34	<a href="#">40.31</a>
V3416	8.0 11.5	LH	Horizontal Sidewall	QR	¾ 20	135, 155, 175, 200	cULus, FM	B, CH, WH, BL, C, N, VC-250	175 12	V34	<a href="#">40.33</a>

Hazard Type		Response Type		Temperature Rating		Sprinkler Finishes	
Light Hazard	LH	Standard Response	SR	135°F	57°C	Plain Brass	B
Ordinary Hazard	OH	Quick Response	QR	155°F	68°C	Chrome plated	CH
LH, OH, Extra and Storage	All	Fast Response	FR	175°F	79°C	White painted	WH
Residential	Res	Open	Open	200°F	93°C	Black painted	BL
Specific Application	Spec			286°F	141°C	Custom	C
				360°F	182°C	Nickel Teflon™	N
						VC-250	VC-250
						Wax	W

## Storage

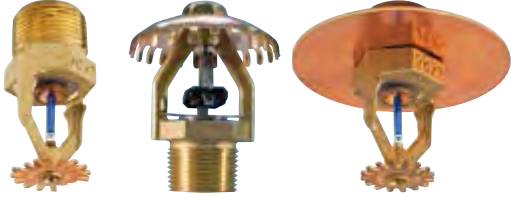

Note: Sprinkler approvals and listings can vary by model, temperature and finish. For complete regulatory information, consult the product submittal publication.

## Standard Response

Model/ SIN	K-Factor Imp.   S.I.	Hazard	Type	Response	Thread Size In.(NPT)   mm	Temperature Rating F   C	Approvals	Sprinkler Finish	Max. Pressure PSI   Bar	Wrench	Submittal
V2721	5.6 8.1	All	Upright	SR	½ 15	135, 155, 175, 200, 286	cULus, FM	B, VC-250	175 12	V27, V38	<a href="#">40.22</a>
V2723	5.6 8.1	All	Pendent	SR	½ 15	135, 155, 175, 200, 286	cULus, FM	B, VC-250	175 12	V27, V38	<a href="#">40.22</a>
V3403	11.2 16.1	All	Upright	SR	¾ 20	135, 155, 175, 200, 286	cULus, FM, GOST	B, CH, WH, N, VC-250	175 12	V44	<a href="#">40.20</a>
V3407	11.2 16.1	All	Pendent	SR	¾ 20	135, 155, 175, 200, 286	cULus, FM, GOST	B, CH, WH, N, VC-250	175 12	V44	<a href="#">40.20</a>
V3417	8.0 11.5	All	Upright	SR	¾ 20	135, 155, 175, 200, 286	cULus, FM	B, VC-250	175 12	V34	<a href="#">40.23</a>
V3419	8.0 11.5	All	Pendent	SR	¾ 20	135, 155, 175, 200, 286	cULus, FM	B, VC-250	175 12	V34	<a href="#">40.23</a>
V4601	25.2 36.8	All	LP-46 Low Pressure Pendent	SR	1 25	162, 212, 286	cULus, FM	B	175 12	V46	<a href="#">40.95</a>
V4603	25.2 36.8	All	LP-46 Low Pressure Upright	SR	1 25	162, 212, 286	FM	B	175 12	V46	<a href="#">40.98</a>

Hazard Type		Response Type		Temperature Rating		Sprinkler Finishes	
Light Hazard	LH	Standard Response	SR	135°F	57°C	Plain Brass	B
Ordinary Hazard	OH	Quick Response	QR	155°F	68°C	Chrome plated	CH
LH, OH, Extra and Storage	All	Fast Response	FR	175°F	79°C	White painted	WH
Residential	Res	Open	Open	200°F	93°C	Black painted	BL
Specific Application	Spec			286°F	141°C	Custom	C
				360°F	182°C	Nickel Teflon™	N
						VC-250	VC-250
						Wax	W

# Storage

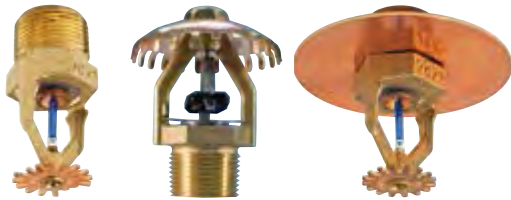

Note: Sprinkler approvals and listings can vary by model, temperature and finish. For complete regulatory information, consult the product submittal publication.

Quick Response											
Model/ SIN	K-Factor Imp.   S.I.	Hazard	Type	Response	Thread Size In.(NPT)   mm	Temperature Rating F   C	Approvals	Sprinkler Finish	Max. Pressure PSI   Bar	Wrench	Submittal
V2722	5.6 8.1	All	Upright	QR	½ 15	135, 155, 175, 200, 286	cULus, FM	B, VC-250	175 12	V27, V38	<a href="#">40.22</a>
V2724	5.6 8.1	All	Pendent	QR	½ 15	135, 155, 175, 200, 286	cULus, FM	B, VC-250	175 12	V27, V38	<a href="#">40.22</a>
V3404	11.2 16.1	All	Upright	QR	¾ 20	135, 155, 175, 200, 286	cULus, FM, GOST	B, CH, WH, N, VC-250	175 12	V44	<a href="#">40.20</a>
V3408	11.2 16.1	All	Pendent	QR	¾ 20	135, 155, 175, 200, 286	cULus, FM, GOST	B, CH, WH, N, VC-250	175 12	V44	<a href="#">40.20</a>
V3418	8.0 11.5	All	Upright	QR	¾ 20	135, 155, 175, 200, 286	cULus, FM	B, VC-250	175 12	V34	<a href="#">40.23</a>
V3420	8.0 11.5	All	Pendent	QR	¾ 20	135, 155, 175, 200, 286	cULus, FM	B, VC-250	175 12	V34	<a href="#">40.23</a>

Hazard Type		Response Type		Temperature Rating		Sprinkler Finishes	
Light Hazard	LH	Standard Response	SR	135°F	57°C	Plain Brass	B
Ordinary Hazard	OH	Quick Response	QR	155°F	68°C	Chrome plated	CH
LH, OH, Extra and Storage	All	Fast Response	FR	175°F	79°C	White painted	WH
Residential	Res	Open	Open	200°F	93°C	Black painted	BL
Specific Application	Spec			286°F	141°C	Custom	C
				360°F	182°C	Nickel Teflon™	N
						VC-250	VC-250
						Wax	W

## Residential



Note: Sprinkler approvals and listings can vary by model, temperature and finish. For complete regulatory information, consult the product submittal publication.

## Quick Response

Model/ SIN	K-Factor Imp.   S.I.	Hazard	Type	Response	Thread Size In.(NPT)   mm	Temperature Rating F   C	Approvals	Sprinkler Finish	Max. Pressure PSI   Bar	Wrench	Submittal
V2738	4.2 6.0	Res	Horizontal Sidewall	QR	½ 15	155, 175	cULus	B, CH, WH, BL, C, VC-250	175 12	V27, V27-2	<a href="#">40.54</a>
V2740	4.9 7.1	Res	Pendent	QR	½ 15	155, 175	cULus	B, CH, WH, C, VC-250	175 12	V27, V27-1	<a href="#">40.47</a>
V2742	4.9 7.1	Res	Concealed Pendent	QR	½ 15	155	cULus	CH, WH, BL, C, VC-250	175 12	V39, V27-2	<a href="#">40.52</a>
V2744	5.6 8.1	Res	Horizontal Sidewall	QR	½ 15	155, 175	cULus	B, CH, WH, C, VC-250	175 12	V27, V27-2	<a href="#">40.49</a>
V2902	6.9 9.9	Res	Pendent	QR	½ 15	155	cULus	B, CH, WH, BL, C	175 12	V29	<a href="#">40.44</a>
V3426	6.9 9.9	Res	Pendent	QR	¾ 20	155, 175	cULus	B, CH, WH, C, VC-250	175 12	V34	<a href="#">40.48</a>
V3806	5.6 8.1	Res	Concealed Pendent	QR	½ 15	155	cULus	B, CH, WH, BL, C	175 12	V38-4	<a href="#">40.43</a>

Hazard Type		Response Type		Temperature Rating		Sprinkler Finishes	
Light Hazard	LH	Standard Response	SR	135°F	57°C	Plain Brass	B
Ordinary Hazard	OH	Quick Response	QR	155°F	68°C	Chrome plated	CH
LH, OH, Extra and Storage	All	Fast Response	FR	175°F	79°C	White painted	WH
Residential	Res	Open	Open	200°F	93°C	Black painted	BL
Specific Application	Spec			286°F	141°C	Custom	C
				360°F	182°C	Nickel Teflon™	N
						VC-250	VC-250
						Wax	W

# Specific Application



Note: Sprinkler approvals and listings can vary by model, temperature and finish. For complete regulatory information, consult the product submittal publication.

Quick Response											
Model/ SIN	K-Factor Imp.   S.I.	Hazard	Type	Response	Thread Size In.(NPT)   mm	Temperature Rating F   C	Approvals	Sprinkler Finish	Max. Pressure PSI   Bar	Wrench	Submittal
V2502	4.2 6.1	Spec	Upright	QR	½ 15	175	cULus	B	175 12	V25	<a href="#">40.09</a>

Hazard Type		Response Type		Temperature Rating		Sprinkler Finishes	
Light Hazard	LH	Standard Response	SR	135°F	57°C	Plain Brass	B
Ordinary Hazard	OH	Quick Response	QR	155°F	68°C	Chrome plated	CH
LH, OH, Extra and Storage	All	Fast Response	FR	175°F	79°C	White painted	WH
Residential	Res	Open	Open	200°F	93°C	Black painted	BL
Specific Application	Spec			286°F	141°C	Custom	C
				360°F	182°C	Nickel Teflon™	N
						VC-250	VC-250
						Wax	W



## Dry



Note: Sprinkler approvals and listings can vary by model, temperature and finish. For complete regulatory information, consult the product submittal publication.

## Standard Response

Model/ SIN	K-Factor Imp.   S.I.	Hazard	Type	Response	Thread Size In.(NPT)   mm	Temperature Rating F   C	Approvals	Sprinkler Finish	Max. Pressure PSI   Bar	Wrench	Submittal
V3301	5.6 8.1	LH, OH	Concealed Pendent	SR	1 25	135, 155, 165, 200	cULus	B, CH, WH, BL, C	175 12	V33	<a href="#">40.68</a>
V3303	8.0 11.2	LH, OH	Concealed Pendent	SR	1 25	135, 155, 165, 200	cULus	B, CH, WH, BL, C	175 12	V33	<a href="#">40.69</a>
V3601	5.6 8.1	All	Upright	SR	1 25	135, 155, 200, 286	cULus, FM	B, CH, WH, BL, C, N, VC-250, W	175 12	V36	<a href="#">40.62</a>
V3603	8.0 11.2	All	Upright	SR	1 25	135, 155, 200, 286	cULus, FM	B, CH, WH, BL, C, N, VC-250, W	175 12	V36	<a href="#">40.63</a>
V3605	5.6 8.1	All	Pendent	SR	1 25	135, 155, 200, 286	cULus, FM	B, CH, WH, BL, C, N, VC-250, W	175 12	V36	<a href="#">40.60</a>
V3607	8.0 11.2	All	Pendent	SR	1 25	135, 155, 200, 286	cULus, FM	B, CH, WH, BL, C, N, VC-250, W	175 12	V36	<a href="#">40.61</a>
V3609	5.6 8.1	LH	Horizontal Sidewall	SR	1 25	135, 155, 200, 286	cULus, FM	B, CH, WH, BL, C, N, VC-250, W	175 12	V36	<a href="#">40.64</a>
V3611	8.0 11.2	LH, OH	Horizontal Sidewall	SR	1 25	135, 155, 200, 286	cULus	B, CH, WH, BL, C, N, VC-250, W	175 12	V36	<a href="#">40.65</a>

Dry type sprinklers are available in a variety configurations (Flush Mount, Sleeve and Skirt, Plain Barrel, Intermediate, Extended, Recessed). Please refer to the submittal documents for specific details.

Hazard Type		Response Type		Temperature Rating		Sprinkler Finishes	
Light Hazard	LH	Standard Response	SR	135°F	57°C	Plain Brass	B
Ordinary Hazard	OH	Quick Response	QR	155°F	68°C	Chrome plated	CH
LH, OH, Extra and Storage	All	Fast Response	FR	175°F	79°C	White painted	WH
Residential	Res	Open	Open	200°F	93°C	Black painted	BL
Specific Application	Spec			286°F	141°C	Custom	C
				360°F	182°C	Nickel Teflon™	N
						VC-250	VC-250
						Wax	W

Dry



Note: Sprinkler approvals and listings can vary by model, temperature and finish. For complete regulatory information, consult the product submittal publication.

Quick Response

Model/ SIN	K-Factor Imp.   S.I.	Hazard	Type	Response	Thread Size In.(NPT)   mm	Temperature Rating F   C	Approvals	Sprinkler Finish	Max. Pressure PSI   Bar	Wrench	Submittal
V3302	5.6 8.1	LH, OH	Concealed Pendent	QR	1 25	135, 155, 165, 200	cULus	B, CH, WH, BL, C	175 12	V33	<a href="#">40.68</a>
V3304	8.0 11.2	LH, OH	Concealed Pendent	QR	1 25	135, 155, 165, 200	cULus	B, CH, WH, BL, C	175 12	V33	<a href="#">40.69</a>
V3602	5.6 8.1	All	Upright	QR	1 25	135, 155, 200, 286	cULus, FM	B, CH, WH, BL, C, N, VC-250, W	175 12	V36	<a href="#">40.62</a>
V3604	8.0 11.2	All	Upright	QR	1 25	135, 155, 200, 286	cULus, FM	B, CH, WH, BL, C, N, VC-250, W	175 12	V36	<a href="#">40.63</a>
V3606	5.6 8.1	All	Pendent	QR	1 25	135, 155, 200, 286	cULus, FM	B, CH, WH, BL, C, N, VC-250, W	175 12	V36	<a href="#">40.60</a>
V3608	8.0 11.2	All	Pendent	QR	1 25	135, 155, 200, 286	cULus, FM	B, CH, WH, BL, C, N, VC-250, W	175 12	V36	<a href="#">40.61</a>
V3610	5.6 8.1	LH	Horizontal Sidewall	QR	1 25	135, 155, 200, 286	cULus, FM	B, CH, WH, BL, C, N, VC-250, W	175 12	V36	<a href="#">40.64</a>
V3612	8.0 11.2	LH, OH	Horizontal Sidewall	QR	1 25	135, 155, 200, 286	cULus	B, CH, WH, BL, C, N, VC-250, W	175 12	V36	<a href="#">40.65</a>

Dry type sprinklers are available in a variety configurations (Flush Mount, Sleeve and Skirt, Plain Barrel, Intermediate, Extended, Recessed). Please refer to the submittal documents for specific details.

Hazard Type		Response Type		Temperature Rating		Sprinkler Finishes	
Light Hazard	LH	Standard Response	SR	135°F	57°C	Plain Brass	B
Ordinary Hazard	OH	Quick Response	QR	155°F	68°C	Chrome plated	CH
LH, OH, Extra and Storage	All	Fast Response	FR	175°F	79°C	White painted	WH
Residential	Res	Open	Open	200°F	93°C	Black painted	BL
Specific Application	Spec			286°F	141°C	Custom	C
				360°F	182°C	Nickel Teflon™	N
						VC-250	VC-250
						Wax	W

## Nozzles



Note: Sprinkler approvals and listings can vary by model, temperature and finish. For complete regulatory information, consult the product submittal publication.

## Open Response

Model/ SIN	K-Factor Imp.   S.I.	Hazard	Type	Response	Thread Size In.(NPT)   mm	Temperature Rating F   C	Approvals	Sprinkler Finish	Max. Pressure PSI   Bar	Wrench	Submittal
V1001	1.4 2.0	—	Window Sprinkler	Open	½ 15	Open	cULus, GOST	B, CH	175 12	V27	<a href="#">40.72</a>
V1003	2.0 2.9	—	Window Sprinkler	Open	½ 15	Open	cULus, GOST	B, CH	175 12	V27	<a href="#">40.72</a>
V1005	2.8 4.0	—	Window Sprinkler	Open	½ 15	Open	cULus, GOST	B, CH	175 12	V27	<a href="#">40.72</a>
V1007	4.2 5.9	—	Window Sprinkler	Open	½ 15	Open	cULus, GOST	B, CH	175 12	V27	<a href="#">40.72</a>
V1009	5.6 8.1	—	Window Sprinkler	Open	½ 15	Open	cULus, GOST	B, CH	175 12	V27	<a href="#">40.72</a>
V1011	8.0 11.5	—	Window Sprinkler	Open	½ 15	Open	cULus, GOST	B, CH	175 12	V27	<a href="#">40.72</a>
V1013	11.5 16.3	—	Window Sprinkler	Open	½ 15	Open	cULus, GOST	B, CH	175 12	V27	<a href="#">40.72</a>
V2601	2.8 4.0	—	Foam Nozzle	Open	½ 15	Open	cULus	B	175 12	V26	<a href="#">40.73</a>
V2603	5.6 8.1	—	Foam Nozzle	Open	½ 15	Open	cULus, GOST	B	175 12	V26	<a href="#">40.73</a>
V1201 - V1278	1.2 – 7.2 1.7 – 10.4	—	Open Spray Nozzle	Open	½ 15	Open	cULus, FM, GOST	B, N, VC-250	175 12	V27	<a href="#">40.96</a>

Hazard Type		Response Type		Temperature Rating		Sprinkler Finishes	
Light Hazard	LH	Standard Response	SR	135°F	57°C	Plain Brass	B
Ordinary Hazard	OH	Quick Response	QR	155°F	68°C	Chrome plated	CH
LH, OH, Extra and Storage	All	Fast Response	FR	175°F	79°C	White painted	WH
Residential	Res	Open	Open	200°F	93°C	Black painted	BL
Specific Application	Spec			286°F	141°C	Custom	C
				360°F	182°C	Nickel Teflon™	N
						VC-250	VC-250
						Wax	W

## Wrenches



Wrench Model														
Wrench Type	Model V25	Model V26 Foam Nozzle	Model V27	Model V27-2	Model V29 Flush	Model V29-1	Model V33	Model V34	Model V36	Model V38-4	Model V38-5 Cabinet Socket	Model V39	Model V44	Model V46
Open End	•	•	•					•	•				•	•
Recessed				•				•	•					
Socket					•	•	•			•	•			
Flush					•	•								
Concealed				•			•		•	•	•	•		

[Download submittal 40.80](#) for complete information

## Accessories



Sprinkler Guards

[Download submittal 40.83](#) for complete information



Sprinkler Storage Cabinet

[Download submittal 40.81](#) for complete information



Expansion Plate

[Download submittal 40.84](#) for complete information



Sprinkler Escutcheon

[Download submittal 40.88](#) for complete information

## Victaulic Vortex™

The *Victaulic Vortex* fire suppression system is built on Victaulic® innovation and product development experience and provides the best capabilities of both water mist and inert gas systems. The homogeneous mixture of water droplets and nitrogen gas is discharged with enough energy to overcome the drag effect that has limited the effectiveness of traditional water mist systems.

The *Victaulic Vortex* system utilizes an active release system to discharge nitrogen upon activation. The average *Victaulic Vortex* droplet size is around 10 microns, and the minimal amount of water released per emitter as little as ¼ gallon or 1 litre per minute. Virtually eliminates any wetting in a space. The system uses 97% less water than high-pressure water mist systems. No costly clean up or equipment replacement.

### The only hybrid nitrogen-water fire suppression system with:

- Green design that is safe for the environment and personnel
- Quick system recharge; minimal facility downtime
- No need for assurance of tight room integrity



### Victaulic Vortex

page



*Victaulic Vortex* 500

56



*Victaulic Vortex* 1000

56



*Victaulic Vortex* 1500

56

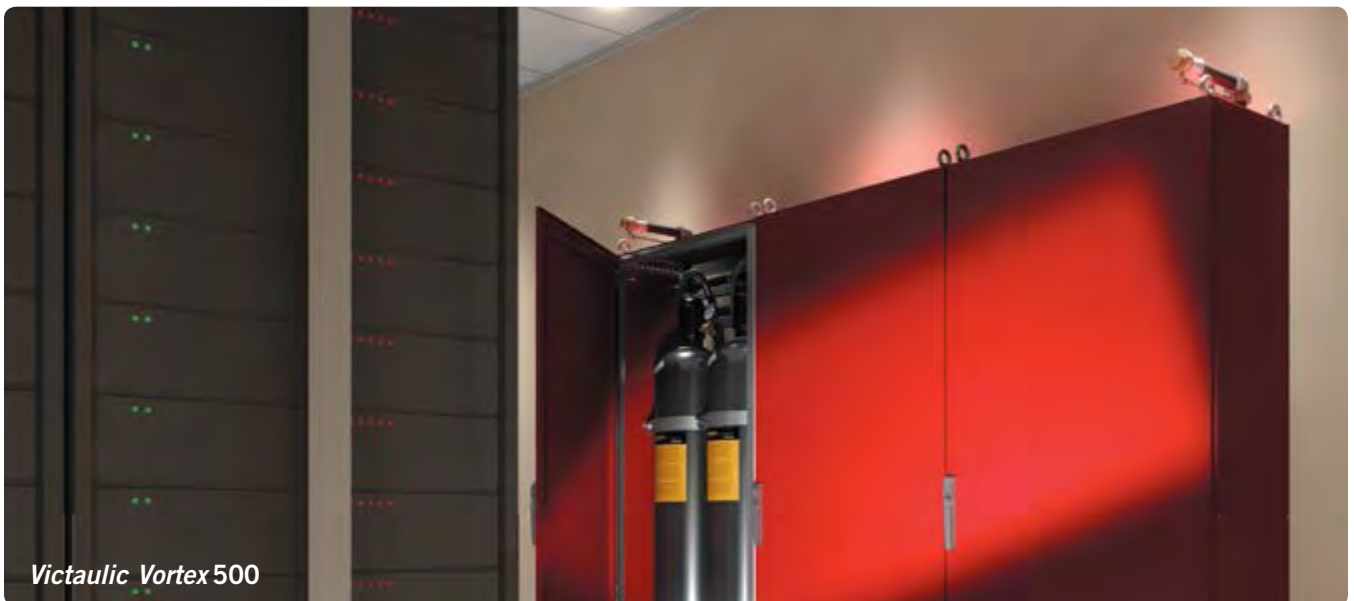

*Victaulic Vortex* 500





## Victaulic Vortex™ 500 Fire Suppression System

[Download submittal 70.01](#) for complete information

- Self-contained, requiring no additional piping once placed in the risk area
- Maximum elevation above sea level: 10,000 ft | 3,048 m
- Enclosure Volume: 500–6,100 ft<sup>3</sup> | 14–173 m<sup>3</sup>

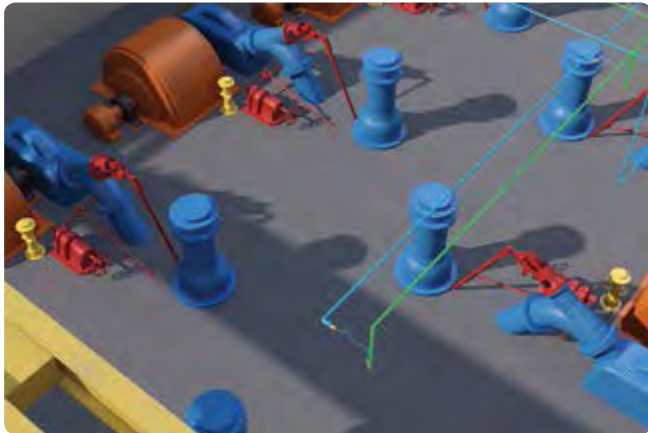

## Victaulic Vortex™ 1000 Fire Suppression System

[Download submittal 70.02](#) for complete information

- FM Approved under the FM5580 standard for Fixed Extinguishing Systems, Hybrid (Water and Inert Gas) for the protection of combustion turbines, machinery spaces, and special hazard machinery spaces in enclosures with volumes not exceeding 127,525 ft<sup>3</sup> | 3600 m<sup>3</sup> and a maximum height of 24.6 ft | 7.5 m
- Touchscreen interface provides a simplified view into the operational aspects of the system

**Approvals/Listings:**



## Victaulic Vortex™ 1500 Fire Suppression System

[Download submittal 70.03](#) for complete information

- Can effectively be applied in total flooding fire suppression applications in the following areas: Industrial machine spaces such as power generation plants, turbine enclosures, automotive manufacturing, steel foundry, flammable liquids storage, data centers, museums, libraries, or mining facilities
- Touchscreen interface provides a simplified view into the operational aspects of the system

## Specialty Systems

For special fire protection applications, Victaulic® delivers a variety of piping product solutions. From plain end HDPE, stainless steel and carbon steel, to grooved AWWA size ductile iron, carbon steel and stainless steel piping, whatever your need Victaulic has a full line of products to make the installation faster, easier and more economical.

Victaulic provides a variety of joining systems and materials for almost any fire protection application. Victaulic products are designed to meet the needs of the most demanding systems.







For the most up-to-date information on our specialty line of products please visit the Victaulic web site at [victaulic.com](http://victaulic.com).

Vic-Press™ stainless steel  
press tool PFT510



## Specialty Systems

### page

	Vic-Press™ for Schedule 10S Stainless Steel Piping	58
	Plain End Piping System	58
	HDPE Piping System	59
	Copper Piping System	59
	Stainless Steel Piping System	60
	AWWA Piping Systems for North America	60



## Vic-Press™ for Schedule 10S Stainless Steel Piping

For the most up-to-date information please visit [victaulic.com/vicpress](http://victaulic.com/vicpress)

Revolutionary *Vic-Press* technology is now globally available for use on ASTM A-312 Schedule 10S stainless steel pipe. The *Vic-Press* for Schedule 10S system features an established and reliable technology that does not require special pipe. *Vic-Press* is now available for standard off-the-shelf stainless steel pipe, providing quick, easy and safe installation and maintenance.

### Approvals/Listings:



[Download publication 10.01](#) for complete information



## Plain End Piping System

For the most up-to-date information please visit [victaulic.com](http://victaulic.com)

The Victaulic® plain end piping method is ideal for maintenance and repairs as well as new system installation. *Roust-A-Bout* couplings and plain end fittings are UL and ULC Listed for fire protection services.

Victaulic plain end couplings are primarily designed for use on standard weight steel pipe (Schedule 40), but may be used on lightwall steel or other metallic pipe such as aluminum or stainless steel. No special pipe end preparation is necessary.

They are not intended for use on plastic pipe, plastic-coated pipe or brittle pipe, such as asbestos cement or cast iron. Nor are they intended for use on pipe with a surface hardness greater than 150 Brinell.

### Approvals/Listings:



[Download publication 10.01](#) for complete information



## HDPE Piping System

For the most up-to-date information please visit [victaulic.com](http://victaulic.com)

The Victaulic® HDPE system provides easy incorporation of standard IPS fittings and valves directly to HDPE pipe using the HDPE-to-grooved transition coupling. The Victaulic system permits more accurate estimates and assures on-time modification and future retrofit. Unique mechanical features permit a wide variety of applications for most HDPE piping systems. It combines the advantages of fast installation, design integrity and reliable operation. Victaulic products for HDPE piping systems are FM Approved for underground water supplies.

### Approvals/Listings:



[Download publication 10.01](#) for complete information



## Copper Piping System

For the most up-to-date information please visit [victaulic.com](http://victaulic.com)

The Victaulic grooved copper system offers a full line of couplings, fittings, flange adapters and valves rated up to 300 psi | 2068 kPa | 20 bar. The copper connection system joins 2–8" | 50–200 mm copper.

### Approvals/Listings:

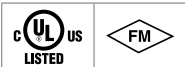

[Download publication 10.01](#) for complete information



## Stainless Steel Piping System

For the most up-to-date information please visit [victaulic.com](http://victaulic.com)

For fast, economical joining of Schedule 5, 10, 20, and 40 stainless steel pipe, you will find a complete line of roll or cut grooved stainless mechanical pipe joining products from Victaulic®.



## AWWA Piping Systems for North America

For the most up-to-date information please visit [victaulic.com](http://victaulic.com)

The Victaulic grooved system for AWWA pipe offers a full line of couplings, fittings, flange adapters and valves for use on AWWA C-606 class 53 pipe or heavier and have a pressure rating of up to 500 psi | 3447 kPa | 34 bar combined with a size range from 3–36" | 80–900 mm.

### Approvals/Listings:

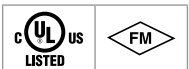

[Download publication 10.01](#) for complete information



## Roll Groove

Victaulic® was the first to develop roll grooving tools in the 1950's and continues to lead the industry in developing tools that make the job faster and easier to install. Victaulic was the first company to receive approval for use of grooved pipe on fire protection systems.

Victaulic offers a variety of tools for pipe preparation, cutting holes, in-place repairs and system maintenance.

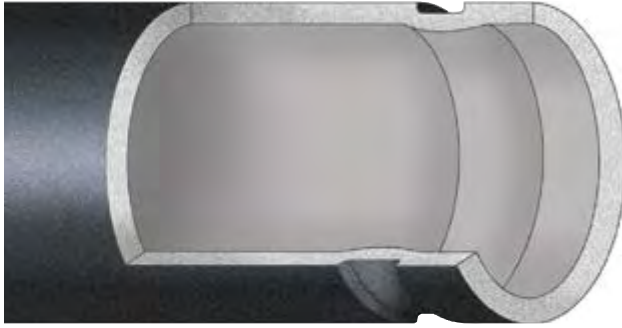

Roll groove shown on Schedule 40 steel pipe. The small dimple created on the interior pipe wall does not significantly affect pressure or flow.

## Roll Grooving Process

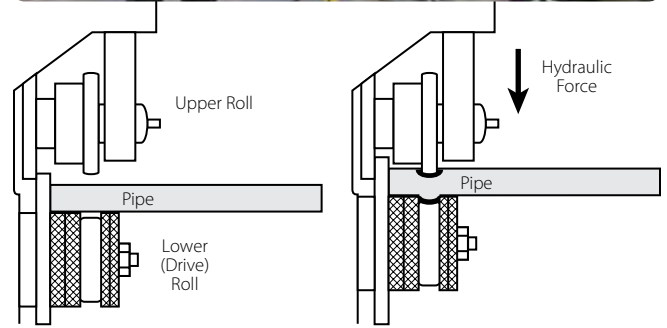



*Vic-Easy* tools cold form groove into pipe – maintains dimensions

Roll grooving removes no metal from pipe

### Field Portable Roll Grooving Tools

	page
 VE12	62
 VE26	62
 VE46	63
 VE226	64
 VE206	65
 VE106/107	66

### Field Fabrication Roll Grooving Tools

	page
 VE270FSD/VE271FSD	67
 VE272SFS	68
 VE416FSD/VE417FSD	69

### Plant/Shop Fabrication Roll Grooving Tools

	page
 VE268	70

### Cut Grooving Tools

	page
 VG28GD	71
 VG	71

### Vic-Press™ Tools

	page
 PFT510	72

### Hole Cutting Tools

	page
 HCT908	72
 VHCT900	73
 VIC-TAP II	73

### Tool Accessories

	page
 VPD752	74
 Power Mule II	74
 VAPS112	75

## Field Portable Roll Grooving Tools

### VE12 GROOVE IN-PLACE

[Download submittal 24.01](#) for complete information

- Tool is manually operated using the supplied ratchet handle
- Enhanced tracking rolls allow bi-directional grooving
- Power Requirements: None
- Weight: 17 lbs. | 8 kg



Tool Ratings — Maximum Capacity <sup>1</sup>		Pipe Size (in   mm)/Schedule				
Model	Pipe Material	¾ 20	1 25	1¼ 32	1½ 40	2 50
VE12	Steel	5-10				
	Stainless	40S				
	Aluminum <sup>2</sup>	5-10				
	PVC Plastic	40				
VE12SS	Lt. Wall SS	5S-10S				

<sup>1</sup> Indicates pipe size capacity. For wall thickness capacity and general tool ratings see separate Vic-Easy Tool Rating Data by [downloading submittal 24.01](#).

<sup>2</sup> 6061-T4 or 6063-T4 alloy must be used.

## Field Portable Roll Grooving Tools

### VE26 GROOVE IN-PLACE

[Download submittal 24.01](#) for complete information

- Tool is manually operated using the supplied ratchet handle
- Enhanced tracking rolls allow bi-directional grooving
- Optional power drive adapter kit available to alternately groove pipe using a Victaulic® VPD752 or a compatible power drive
- Power Requirements: None
- Weight: 22 lbs. | 10 kg



Tool Ratings — Maximum Capacity <sup>1</sup>		Pipe Size (in   mm)/Schedule					
Model	Pipe Material	2 50	2½ 60	3 80	4 100	5 125	6 150
VE26S	Steel	5-40		5-10			
	Stainless	40S Only					
VE26C	Copper	K, L, M and DWV					
VE26P	Aluminum <sup>2</sup>	5-40		5-10			
	PVC Plastic	40					
VE26SS	Lt. Wall SS	5S-10S					

<sup>1</sup> Indicates pipe size capacity. For wall thickness capacity and general tool ratings see separate Vic-Easy Tool Rating Data by [downloading submittal 24.01](#).

<sup>2</sup> 6061-T4 or 6063-T4 alloy must be used.

## Pipe Preparation Tools



### Field Portable Roll Grooving Tools

#### VE46 GROOVE IN-PLACE

[Download submittal 24.01](#) for complete information

- Tool is manually operated using the supplied ratchet handle
- Enhanced tracking rolls allow bi-directional grooving and helps to hold the tool on the pipe end during the roll grooving process
- Optional power drive adapter kit available to alternately groove pipe using a Victaulic® VPD752 or a compatible power drive
- Power Requirements: None
- Weight: 28 lbs. | 13 kg

Tool Ratings — Maximum Capacity <sup>1</sup>		Pipe Size (in   mm) / Schedule				
Model	Pipe Material	3½ 90	4 100	4½ 120	5 125	6 150
VE46S	Steel	5 – 40				
	Stainless	40S Only				
VE46P	Aluminum <sup>2</sup>	5 – 40				
	PVC Plastic	40				

<sup>1</sup> Indicates pipe size capacity. For wall thickness capacity and general tool ratings see separate *Vic-Easy* Tool Rating Data by [downloading submittal 24.01](#).

<sup>2</sup> 6061-T4 or 6063-T4 alloy must be used.

## Field Portable Roll Grooving Tools

### VE226 PORTABLE GROOVER

[Download submittal 24.01](#) for complete information



- Tool is operated using a standard 3/8" | 9.5 mm square ratchet drive (not included)
- Drive Requirements: Mounts to Victaulic® VPD752 or a compatible power drive; optional bases available
- Weight: 37 lbs. | 17 kg

Tool Ratings — Maximum Capacity <sup>1</sup>

Model	Pipe Material	Pipe Size (in   mm)/Schedule											
		3/4 20	1 25	1 1/4 32	1 1/2 40	2 50	2 1/2 60	3 80	3 1/2 90	4 100	4 1/2 120	5 125	6 150
VE226S	Steel	5-40				5-10							
	Stainless	40S Only											
VE226B	Steel	5-40											
	Stainless	40S Only											
	Aluminum <sup>2</sup>	5-40											
	PVC Plastic	40											
VE226M	Steel					5-40				5-10			
	Stainless	40S Only											
VE226C	Copper	K, L, M and DWV											
VE226BSS	Lt. Wall SS	5S-10S											
VE226MSS	Lt. Wall SS	5S-10S											
VE226P	Aluminum <sup>2</sup>					5-40				5-10			
	PVC Plastic					40							

<sup>1</sup> Indicates pipe size capacity. For wall thickness capacity and general tool ratings see separate Vic-Easy Tool Rating Data by [downloading submittal 24.01](#).

<sup>2</sup> 6061-T4 or 6063-T4 alloy must be used.

## Field Portable Roll Grooving Tools

VE206

[Download submittal 24.01](#) for complete information



- Tool head mounts to any tripod stand with a Ridgid™ 300 bolt pattern or the flat bed of a roustabout truck
- Compatible with multiple power drive units; Victaulic® VPD752, Ridgid™ 300 or 700, and Rems Amigo 2
- Hydraulic hand pump can be mounted on either side of the tool for right or left hand operation
- Roll grooves 1¼–6" | 32–150 mm pipe

Tool Ratings — Maximum Capacity <sup>1</sup>		Pipe Size (in   mm)/Schedule								
Model	Pipe Material	1¼ 32	1½ 40	2 50	2½ 60	3 80	3½ 90	4 100	5 125	6 150
VE106/VE107	Steel <sup>2,3</sup>	5–40								
	Stainless <sup>2</sup>	40S								
	Lt. Wall SS <sup>4</sup>	5S–10S								
	Copper <sup>5</sup>	K, L, M and DWV								

<sup>1</sup> Indicates pipe size capacity. For wall thickness capacity and general tool ratings see separate *Vic-Easy* Tool Rating Data by [downloading submittal 24.01](#).

<sup>2</sup> Use standard grooving rolls marked with the prefix R.

<sup>3</sup> EndSeal™ grooving rolls marked with the prefix RZ are available. Contact Victaulic for details.

<sup>4</sup> Use grooving rolls marked with the prefix RX.

<sup>5</sup> Use grooving rolls marked with the prefix RR.



## Field Portable Roll Grooving Tools

### VE106/VE107 GROOVE-N-GO

[Download submittal 24.01](#) for complete information



- Mobile, light-duty roll grooving tool with an integral motor/drive unit mounted to portable hand truck
- Reduces pipe handling by allowing the tool to be wheeled directly to the pipe preparation site
- 3/8" | 9.5 mm square ratchet drive for operation (standard)
- Enhanced tracking rolls help to keep the pipe on the tool during the roll grooving process
- Completely self-contained unit with an integral motor, safety foot switch and power plug
- Power Requirements:  
VE106 is provided with 110 volt, 15 amp power;  
VE107 is provided with 220 volt, 6 amp power
- Weight: 140 lbs. | 64 kg

Tool Ratings — Maximum Capacity <sup>1</sup>		Pipe Size (in   mm)/Schedule								
Model	Pipe Material	1¼ 32	1½ 40	2 50	2½ 60	3 80	3½ 90	4 100	5 125	6 150
VE106/VE107	Steel <sup>2,3</sup>	5 – 40								
	Stainless <sup>2</sup>	40S								
	Lt. Wall SS <sup>4</sup>	5S – 10S								
	Copper <sup>5</sup>	K, L, M and DWV								

<sup>1</sup> Indicates pipe size capacity. For wall thickness capacity and general tool ratings see separate *Vic-Easy* Tool Rating Data by [downloading submittal 24.01](#).  
<sup>2</sup> Use standard grooving rolls marked with the prefix R.  
<sup>3</sup> EndSeal™ grooving rolls marked with the prefix RZ are available. Contact Victaulic® for details.  
<sup>4</sup> Use grooving rolls marked with the prefix RX.  
<sup>5</sup> Use grooving rolls marked with the prefix RR.



## Field Fabrication Roll Grooving Tools

VE270FSD/VE271FSD

[Download submittal 24.01](#) for complete information

- Completely self-contained unit with integral gear motor, safety guards, safety foot switch and power cord/plug
- Equipped with a unique pivot arm design, making roll changing quick and easy without removing shafts
- Enhanced tracking rolls help to keep the pipe on the tool during the roll grooving process
- The fully-motorized, semi-automatic, electrohydraulic tool comes complete with safety guards and safety foot switch
- Power Requirements:  
VE270FSD is provided with 110 volt, 15 amp power;  
VE271FSD is provided with 220 volt, 6 amp power
- Weight: 340 lbs. | 154 kg

**Tool Ratings — Maximum Capacity** <sup>1</sup>

Model	Pipe Material	Pipe Size (in   mm)/Schedule													
		¾ 20	1 25	1¼ 32	1½ 40	2 50	2½ 60	3 80	3½ 90	4 100	5 125	6 150	8 200	10 250	12 300
VE270FSD/ VE271FSD	Steel <sup>2,3</sup>	5 – 40												5 – 20	
	Stainless <sup>2</sup>	40S												.250	
	Lt. Wall SS <sup>4</sup>	5S – 10S													
	Aluminum <sup>5</sup>	5 – 40												5 – 20	
	PVC Plastic <sup>6</sup>	40													
	Copper <sup>7</sup>	K, L, M and DWV													

<sup>1</sup> Indicates pipe size capacity. For wall thickness capacity and general tool ratings see separate *Vic-Easy* Tool Rating Data by [downloading submittal 24.01](#).

<sup>2</sup> Use standard grooving rolls marked with the prefix R.

<sup>3</sup> EndSeal™ grooving rolls marked with the prefix RZ are available. Contact Victaulic® for details.

<sup>4</sup> Use grooving rolls marked with the prefix RX.

<sup>5</sup> 6061-T4 or 6063-T4 alloy must be used.

<sup>6</sup> Use grooving rolls marked with the prefix RP.

<sup>7</sup> Use grooving rolls marked with the prefix RR.

# Field Fabrication Roll Grooving Tools

## VE272SFS

[Download submittal 24.01](#) for complete information



- Hand pump operation with a unique pivot arm design reduces handle effort
- Enhanced tracking rolls help to keep the pipe on the tool during the roll grooving process
- The fully-motorized, semi-automatic, electrohydraulic tool comes complete with safety guards and safety foot switch
- Power Requirements: Victaulic® VPD752 or a compatible power drive
- Weight: 184 lbs. | 84 kg

Tool Ratings — Maximum Capacity <sup>1</sup>		Pipe Size (in   mm)/Schedule													
Model	Pipe Material	¾ 20	1 25	1¼ 32	1½ 40	2 50	2½ 60	3 80	3½ 90	4 100	5 125	6 150	8 200	10 250	12 300
VE272SFS	Steel <sup>2,3</sup>	5 – 40												5 – 20	
	Stainless <sup>2</sup>	40S												.250	
	Lt. Wall SS <sup>4</sup>	5S – 10S													
	Aluminum <sup>5</sup>	5 – 40												5 – 20	
	PVC Plastic <sup>6</sup>	40													
	Copper <sup>7</sup>	K, L, M and DWV													

<sup>1</sup> Indicates pipe size capacity. For wall thickness capacity and general tool ratings see separate *Vic-Easy* Tool Rating Data by [downloading submittal 24.01](#).

<sup>2</sup> Use standard grooving rolls marked with the prefix R.

<sup>3</sup> EndSeal™ grooving rolls marked with the prefix RZ are available. Contact Victaulic for details.

<sup>4</sup> Use grooving rolls marked with the prefix RX.

<sup>5</sup> 6061-T4 or 6063-T4 alloy must be used.

<sup>6</sup> Use grooving rolls marked with the prefix RP.

<sup>7</sup> Use grooving rolls marked with the prefix RR.



## Field Fabrication Roll Grooving Tools

### VE416FSD/VE417FSD

[Download submittal 24.01](#) for complete information

- VE416FSD/VE417FSD is designed for field grooving of OGS pipe and should not be used for continuous field production grooving; For field production grooving capabilities, use a VE450FSD tool, see pg. 95
- Groove depth adjuster allows for easy adjustment for initial groove diameter
- Completely self-contained units with integral gear motors, safety foot switch and power cord/plug
- The fully-motorized, semi-automatic, electrohydraulic tool comes complete with safety guards and safety foot switch
- Power Requirements:  
VE416FSD is provided with 110 volt, 15 amp for integral gear motor;  
VE417FSD is provided with 220 volt, 8 amp service
- Weight: 340 lbs. | 154 kg

#### Tool Ratings — Maximum Capacity<sup>1</sup>

Model	Pipe Material	Pipe Size (in   mm)/Schedule									
		OGS									
		2 50	2½ 60	3 80	4 100	5 125	6 150	8 200	10 250	12 300	
VE416FSD/ VE417FSD	Steel <sup>2,3</sup>	5 – 40								10 – STD	
	Stainless <sup>2</sup>	40S									
	Lt. Wall SS <sup>4</sup>	5S – 10S									
	Aluminum <sup>5,6</sup>	5 – 40								5 – STD	
	PVC Plastic <sup>6</sup>	40									
	Copper <sup>7</sup>	K, L, M and DWV									

<sup>1</sup> Indicates pipe size capacity. For wall thickness capacity and general tool ratings see separate *Vic-Easy* Tool Rating Data by [downloading submittal 24.01](#).

<sup>2</sup> Use standard grooving rolls marked with the prefix R.

<sup>3</sup> EndSeal™ grooving rolls marked with the prefix RZ are available. Contact Victaulic® for details.

<sup>4</sup> Use grooving rolls marked with the prefix RX.

<sup>5</sup> 6061-T4 or 6063-T4 alloy must be used.

<sup>6</sup> Use grooving rolls marked with the prefix RP.

<sup>7</sup> Use grooving rolls marked with the prefix RR.

# Plant/Shop Fabrication Roll Grooving Tools

VE268

[Download submittal 24.01](#) for complete information



- The fully-motorized, semi-automatic, electrohydraulic tool comes complete with safety guards and safety foot switch
- Equipped with a unique pivot arm design, making roll changes quick and easy, without removing shafts
- Enhanced tracking rolls help to keep the pipe on the tool during the roll grooving process
- Power Requirements: 220/440 volt, 3-phase, 60 hertz standard; the tool can also be supplied in various voltages, contact Victaulic® for details
- 3-phase requires tool power to be hard wired by a local certified electrician
- Weight: 735 lbs. | 333 kg

Tool Ratings — Maximum Capacity <sup>1</sup>		Pipe Size (in   mm)/Schedule													
Model	Pipe Material	¾ 20	1 25	1¼ 32	1½ 40	2 50	2½ 60	3 80	3½ 90	4 100	5 125	6 150	8 200	10 250	12 300
VE268	Steel <sup>2,3</sup>	5-40												5-20	
	Stainless <sup>2</sup>	40S													
	Lt. Wall SS <sup>4</sup>	5S-10S													
	Aluminum <sup>5,6</sup>	5-40												5-20	
	PVC Plastic <sup>6</sup>	40													
	Copper <sup>7</sup>	K, L, M and DWV													

<sup>1</sup> Indicates pipe size capacity. For wall thickness capacity and general tool ratings see separate *Vic-Easy* Tool Rating Data by [downloading submittal 24.01](#).

<sup>2</sup> Use standard grooving rolls marked with the prefix R.

<sup>3</sup> EndSeal™ grooving rolls marked with the prefix RZ are available. Contact Victaulic for details.

<sup>4</sup> Use grooving rolls marked with the prefix RX.

<sup>5</sup> 6061-T4 or 6063-T4 alloy must be used.

<sup>6</sup> Use grooving rolls marked with the prefix RP.

<sup>7</sup> Use grooving rolls marked with the prefix RR.



## Pipe Preparation Tools



### Cut Grooving Tools

#### VG28GD (GEAR DRIVE)

[Download submittal 24.01](#) for complete information

- VG28GD will produce a single OGS cut groove for unlined piping systems
- The VG28GD is designed to be driven by the Power Mule II, see pg. 74
- Drive Requirements: External drive, min. 1½ hp | 1.12 kw
- Drive Speed: 38 rpm max.
- Weight: 37 lbs. | 17 kg

Tool Ratings — Maximum Capacity		Pipe Size (in   mm)/Schedule							
Model	Pipe Material	2 50	2½ 65	3 80	3½ 90	4 100	5 125	6 150	8 200
VG28GD <sup>2</sup>	Steel	40–80 <sup>1</sup>							
	Stainless	40–80 <sup>1</sup>							
	Aluminum	40–80 <sup>1</sup>							
	Ductile Iron	Class 53 Min.							

<sup>1</sup> 6" | 150mm Schedule 80

<sup>2</sup> Special knives and stops may be required.



### Cut Grooving Tools

#### VG VIC-GROOVER

[Download submittal 24.01](#) for complete information

- Designed for manual or power cut grooving
- Supplied with a ratchet handle for manual operation
- Drive Requirements: Manual or external drive, min. ½ hp | 0.37 kw
- External power drives must meet all safety conditions
- Drive Speed: 40 rpm max.
- Weight: 28 lbs. | 13 kg

Tool Ratings — Maximum Capacity <sup>1</sup>		Pipe Size (in   mm)/Schedule											
Model	Pipe Material	¾ 20	1 25	1¼ 32	1½ 40	2 50	2½ 60	3 80	3½ 90	4 100	5 125	6 150	8 200
VG	Steel	40–80											
	Stainless	40–80											
	Aluminum <sup>2</sup>	40–80											
	PVC Plastic	40–80											
	Ductile Iron											Cl. 53	Class 53 Min.

<sup>1</sup> Indicates pipe size capacity. For wall thickness capacity and general tool ratings see separate Vic-Easy Tool Rating Data by [downloading submittal 24.01](#).

<sup>2</sup> 6061-T4 or 6063-T4 alloy must be used.



## Vic-Press™ Tools

PFT510

[Download submittal 24.01](#) for complete information

- Designed for securing *Vic-Press* Schedule 10S products onto Schedule 10S stainless steel pipe
- Tool package includes:
  - (1) PFT510 tool,
  - (2) 18V Lithium Ion batteries,
  - (1) battery charger,
  - (1) tool carrying case,
  - (1) jaw carrying case,
  - (1) each of jaws sized ½" | 15 mm, ¾" | 20 mm, 1" | 25 mm, 1½" | 40 mm, and 2" | 50 mm, and
  - (1) adapter jaw
- Not compatible with PFT505 and/or PFT509 tools/components
- Power Requirements: Battery pack 110 volt, 60 cycle, 6.5 amp (optional 220 volt)
- Weight: 21 lbs. | 9.5 kg  
(PFT510 with 1" | 25 mm jaw)



## Hole Cutting Tools

HCT908

[Download submittal 24.01](#) for complete information

- One-piece hole cutting tool designed to cut holes up to 4½" | 120 mm in carbon and stainless steel pipe; for pipe sizes up to 8" | 200 mm
- Allows use of *Mechanical-T* and strapless outlets
- Power Requirements: 110 volt, single phase, 60 hertz, 7 amp
- Weight: 23 lbs. | 10 kg

## Pipe Preparation Tools



### Hole Cutting Tools

#### VHCT900

[Download submittal 24.01](#) for complete information

- Three-piece hole cutting tool designed to cut holes up to 3½" | 90 mm in diameter for *Mechanical-T* and strapless outlets
- Base unit clamps quickly onto the pipe in vertical, horizontal or overhead positions
- Available extended chain for 10–24" | 250–600 mm pipe
- Power Requirements: Grounded 120 volt, single phase, 60 hertz, 10 amp electrical supply (220 volt, single phase, 60 hertz, 5 amp available on request)
- Weight: 36 lbs. | 16 kg



### Hole Cutting Tools

#### VIC-TAP II

[Download submittal 24.01](#) for complete information

- Hole cutting tool including Style 931 Vic-Tap II Mechanical-T unit for tapping into steel pipe systems under pressure up to 500 psi | 3447 kPa | 34 bar
- Hole size 2¾" | 60.5 mm
- Power Requirements: 115 volt, single phase, 60 hertz, 7.5 amp
- Weight:  
Drill guide base: 15 lbs. | 6.8 kg; Drill motor and feed assembly: 16 lbs. | 7.3 kg; Style 931/Valve unit, 12–15 lbs. | 5.4–6.8 kg, depending upon size (4, 5, 6 and 8" | 100, 125, 150, 200 mm available)
- Standard Capability: 4–8" | 100–200 mm run outlet only × 2½" | 65 mm (IPS) outlet



## Tool Accessories

### VPD752 POWER DRIVE

[Download submittal 24.01](#) for complete information

- Can be used as the power drive unit for the VE226, VE26, VE206, VE46, VE416FS and VE272SFS roll grooving tools provided each tool is equipped with the correct base plate and the VG, VG28GD, and VG824 tools, with universal drive shaft
- Operated with a safety foot switch
- Power Requirements: 115 volts, 15 amp, 50/60 hertz (220 volt, 6 amp, 50/60 cycle option)
- Weight: 140 lbs. | 634 kg



## Tool Accessories

### POWER MULE II

[Download submittal 24.01](#) for complete information

- Ideal for driving individual Victaulic® cut grooving tools
- Heavy-duty, two wheeled unit drives Victaulic cut grooving tools at the speed/power necessary for accurate grooving
- Rotating head for horizontal and vertical applications
- Power Mule II equipped with forward-off-reverse control and integral safety foot switch
- Full load speed: 35 rpm
- Power Requirements: 115 volts, 15 amp, 50/60 cycle (220 volts optional)
- Weight: 190 lbs. | 86 kg

## Pipe Preparation Tools



## Tool Accessories

### VAPS112 ADJUSTABLE PIPE STAND

[Download submittal 24.01](#) for complete information

- Designed for supporting pipe to be roll grooved
- Turnstile design allows pipe to be spun around for grooving of both pipe ends without dismounting pipe from stand
- Forward/traverse movement
- Capacity: ¾ – 12" | 20–300 mm IPS pipe
- Load rating: 1,075 lbs. | 490 kg
- Vertical stroke: 14½" | 368 mm for adjusting rod, 8½" | 216 mm leg adjustment 23" | 584 mm
- Minimum pipe height from floor: 23" | 584 mm on 12" | 300 mm pipe and 21" | 533 mm on 1" | 25 mm pipe
- Weight: 190 lbs. | 86 kg



Main content area consisting of multiple horizontal lines for text input.

Intro

VicFlex™

Couplings

Fittings

Hole Cut

Valves and Accessories

Devices and Accessories

Automatic Sprinklers

Victaulic™ Vortex™

Specialty Systems

**Pipe Preparation Tools**

Design Data

Index

## Design Data

### Introduction

This Victaulic® Fire Protection Catalog provides general information on mechanical piping methods and Victaulic products for fire protection systems. For the latest and most up-to-date information, always consult the individual product submittals provided on the Victaulic web site – [victaulic.com](http://victaulic.com). This catalog is organized to provide information in the context and form most readily usable. For easy identification of major sections of interest, see the condensed table of contents on pg. i, for a fully detailed index, see pg. 81. For more detailed design guidelines, consult Design Data, [Publication 26.01](#).

### Important Information

Victaulic standard grooved pipe couplings are designed for use with pipe grooved to meet Victaulic groove specifications and Victaulic grooved end fittings, valves, and related grooved end components only. They are not intended for use with plain end pipe and/or fittings. Victaulic plain end couplings are designed for use only with plain end or beveled end steel pipe (unless otherwise indicated) and Victaulic plain end fittings. **Victaulic plain end couplings must not be used with grooved end threaded pipe and/or fittings.**

Pipe must be prepared to meet Victaulic specifications outlined for each specific product style. Performance data listed herein is based on proper pipe preparation. The proper gasket must be selected for the service intended. **It should be noted that there are various services for which Victaulic gaskets are not recommended. Reference should always be made to the latest Victaulic Gasket Selection Guide (request [Publication 05.01](#)) for specific gasket service recommendations and for a listing of services which are not recommended. Gaskets for Victaulic products always must be lubricated for proper assembly.** Gasket lubricant must meet manufacturer's specifications. Thorough lubrication of the gasket exterior, when required, including the lips and/or pipe ends and housing interiors, is essential to prevent gasket pinching. Lubrication assists proper gasket seating and alignment during installation.

*Victaulic FireLock™* devices require proper set up and maintenance. Always refer to the latest manual included with each valve for details.

When installing *Victaulic FireLock* automatic sprinklers it is important to select the proper wrench for installation. A complete guide for proper installation of Victaulic automatic sprinklers is available by requesting [Publication I-40](#).

Victaulic has a complete line of tools for preparing pipe to Victaulic specifications. Use of these tools is recommended in preparing pipe to receive Victaulic products. Always read and understand the Tool Operating Instructions supplied with every Victaulic tool prior to using any tools. All data contained herein, is subject to change without notice.

### Notice

The technical and performance data, weights, dimensions and specifications published are current as of the date of publication. For the most up-to-date information visit the Victaulic web site for detailed specific product submittal information.

Victaulic maintains a policy of continual product improvement and, therefore, reserves the right to change product specifications, designs, and standard equipment without notice and without incurring obligation.

For the most up-to-date Victaulic product information, please visit [victaulic.com](http://victaulic.com).

The material presented in this catalog is intended for piping design reference in utilization of Victaulic products for their intended application. It is not intended as a substitute for competent, professional assistance which is an obvious requisite to any specific application.

### Design

Reference should always be made to design information available at no charge on request from Victaulic. Good piping practices should always prevail. Specific pressures, temperatures, external or internal loads, performance standards and tolerances must never be exceeded. Many applications require recognition of special conditions, code requirements and use of safety factors. Qualified engineers must make these decisions.

**While every effort has been made to ensure its accuracy, Victaulic, its subsidiaries and affiliated companies, make no express or implied warranty of any kind respecting the information contained in this catalog or the material referred to herein.**

**Anyone making use of the information or material contained herein does so at their own risk and assumes any and all liability resulting from such use.**

## Design Data

### Installation

Reference should always be made to the specific Victaulic® Field Installation Handbook for the product you are installing. The following is a list of handbooks that can be requested for free from Victaulic:

I-40	FireLock™ Automatic Sprinklers
I-100	General Handbook
I-300	AWWA Product Handbook
I-500	Vic-Press™ System Handbook
I-600	Copper Products Handbook
I-751	<i>FireLock</i> Alarm Valve Manual
I-759	<i>FireLock</i> Alarm Valve Manual
I-768	FireLock NXT™ Dry Valve Manual
I-769D	<i>FireLock NXT</i> Deluge Valve Manual
I-769P	<i>FireLock NXT</i> Preaction Valve Manual
I-769P-LPCB	<i>FireLock NXT</i> Preaction Valves for LPCB Approved Applications
I-900	HDPE Products Handbook
I-VicFlex™	<i>VicFlex</i> Sprinkler Fitting System

Handbooks are included with each shipment of Victaulic products for complete installation and assembly data, and are available in PDF format on our website at [victaulic.com](http://victaulic.com).

### Warranty:

We warrant all products to be free from defects in materials and workmanship under normal conditions of use and service. Our obligation under this warranty is limited to repairing or replacing at our option at our factory any product which shall within one year after delivery to original buyer be returned with transportation charges prepaid, and which our examination shall show to our satisfaction to have been defective.

THIS WARRANTY IS MADE EXPRESSLY IN LIEU OF ANY OTHER WARRANTIES, EXPRESS OR IMPLIED, INCLUDING ANY IMPLIED WARRANTY OF MERCHANTABILITY OR FITNESS FOR A PARTICULAR PURPOSE. THE BUYER'S SOLE AND EXCLUSIVE REMEDY SHALL BE FOR THE REPAIR OR REPLACEMENT OF DEFECTIVE PRODUCTS AS PROVIDED HEREIN. THE BUYER AGREES THAT NO OTHER REMEDY (INCLUDING, BUT NOT LIMITED TO, INCIDENTAL OR CONSEQUENTIAL DAMAGES FOR LOST PROFITS, LOST SALES, INJURY TO PERSON OR PROPERTY OR ANY OTHER INCIDENTAL OR CONSEQUENTIAL LOSS) SHALL BE AVAILABLE TO HIM.

Victaulic neither assumes nor authorizes any person to assume for it any other liability in connection with the sale of such products.

**This warranty shall not apply to any product which has been subject to misuse, negligence or accident, which has been repaired or altered in any manner outside of a Victaulic factory or which has been used in a manner contrary to Victaulic instructions or recommendations. Victaulic shall not be responsible for design errors due to inaccurate or incomplete information supplied by Buyer or its representatives.**

Items purchased by Victaulic and resold will have the original equipment manufacturer's warranty extended to Victaulic customers.

## Design Data

### Rounded Inches Decimal Equivalent Per Foot

¼ = .02	¾ = .27	6¼ = .52	9¼ = .77
½ = .04	3½ = .29	6½ = .54	9½ = .79
¾ = .06	3¾ = .31	6¾ = .56	9¾ = .81
1 = .08	4 = .33	7 = .58	10 = .83
1¼ = .10	4¼ = .35	7¼ = .60	10¼ = .85
1½ = .125	4½ = .375	7½ = .625	10½ = .875
1¾ = .15	4¾ = .40	7¾ = .65	10¾ = .90
2 = .17	5 = .42	8 = .67	11 = .92
2¼ = .19	5¼ = .44	8¼ = .69	11¼ = .94
2½ = .21	5½ = .46	8½ = .71	11½ = .96
2¾ = .23	5¾ = .48	8¾ = .73	11¾ = .98
3 = .25	6 = .50	9 = .75	12 = 1.00

### Right Triangle Formula

$c^2 = a^2 + b^2$   
 $A = B - 90^\circ$   
 $B = A - 90^\circ$   
 $A + B + C = 180^\circ$

$\sin A = \frac{a}{c}$   
 $\cos A = \frac{b}{c}$   
 $\tan A = \frac{a}{b}$

---

$\sin B = \frac{b}{c}$   
 $\cos B = \frac{a}{c}$   
 $\tan B = \frac{b}{a}$

### Imperial (U.S.)/Metric Conversion Chart

This chart is provided as a guide for converting imperial and metric measurements provided within this catalog.

Convert Imperial (U.S.) to Metric		⇔	Convert Metric to Imperial (U.S.)			
25.4	×	Inches (In.)	⇔	Millimeters (mm)	×	0.03937
0.3048	×	Feet (Ft.)	⇔	Meters (m)	×	3.281
0.4536	×	Pounds (Lbs.)	⇔	Kilograms (kg)	×	2.205
28.35	×	Ounces (Oz.)	⇔	Grams (g)	×	0.03527
6.894	×	Pressure (psi)	⇔	Kilopascals (kPa)	×	0.145
0.069	×	Pressure	⇔	Bar	×	14.5
4.45	×	End Load (Lbs.)	⇔	Newtons (N)	×	0.2248
1.356	×	Torque (Lb. Ft.)	⇔	Newton Meters (N•m)	×	0.738
F - 32 ÷ 1.8		Temp.(°F)	⇔	Celsius (°C)		C + 17.78 × 1.8
745.7	×	Horsepower (hp)	⇔	Watts (w)	×	1.341 × 10 <sup>-3</sup>
3.785	×	Gal. per Min. (GPM)	⇔	Liters per Min. (L/M)	×	0.2642
3.785	×	10 <sup>-3</sup> Gal. per Min. (GPM)	⇔	Cubic Meters per Min. (m <sup>3</sup> /m)	×	264.2
1.44	×	K-factor (Imperial)	⇔	K-factor (SI)	×	0.69

### Hydraulic Formula

$$Q = K\sqrt{P} \quad K = \frac{Q}{\sqrt{P}}$$

$$P = \left(\frac{Q}{K}\right)^2 \quad [H = E \times .433]$$

Q = Flow  
 P = Pressure  
 K = K-factor  
 E = Elevation in feet  
 H = Head  
 .433 = Water specific density

### Sizing Air Compressor in CFM

$$\frac{VP}{(7.48)(14.7)(T)} = \text{CFM's required}$$

V = Gallons  
 P = Pressure (psi)  
 7.48 = Gallons ft<sup>3</sup>  
 14.7 = Atmospheric pressure  
 T = Time (minutes)

### Triangle Offset Formulas

45° Offset

$B = A (.707)$   
 $A = B (1.414)$

Example:  
 $B = 6''$   
 $A = 6'' \times 1.414$   
 $A = 8.484''$

"Rolling Offset"

$C = \sqrt{A^2 + B^2}$   
 Example:  
 $C = \sqrt{9' + 4'}$   
 $C = 3.60'$





## Index

**VicFlex™ Sprinkler Fitting System**

Series AH2	2
Series AH2-300	2
Series AH1	2
Series AH4	3
Series AH5	3
Style AB1	3
Style AB2	4
Style AB7	4
Style AB7 Adjustable	4
Style AB4	5
Style AB9	5
Style AB8	5
Style AB10	6
Style AB3	6
Style AB6	6
Series AQD	7
Series AQC	7
VicFlex Reducer Nipples and Elbows	7

**Couplings**

AGS Flexible Coupling	13
FireLock EZ™ Rigid Coupling	11
FireLock™ Flange Adapter	15
FireLock Rigid Coupling	11
Flexible Coupling	12
Flexible Coupling	13
High Pressure Rigid Coupling	14
Outlet Coupling	14
QuickVic™ Flexible Coupling	12
QuickVic Rigid Coupling	12
Reducing Coupling	13
Rigid Coupling for Type 316 Stainless Steel	14
Vic-Boltless Coupling and Tool	15
Vic-Flange Adapter	15
Vic-Flange Adapter	16
Zero-Flex™ Rigid Coupling	11

**Fittings**

Drain Elbow	18
FireLock Fittings	17
Standard Grooved End Fittings	18
Vic™-End II End of Run Elbow	18

**Hole Cut Systems**

FireLock Low Profile Sprinkler Tee – EMEA only	20
FireLock Outlet-T	19
Mechanical-T Outlet	20
Strapless Outlet	20

**Valves and Accessories**

Brass Body Threaded Ball Valve	25
FireLock Ball Valve	25
FireLock Butterfly Valve – Supervised Closed	22
FireLock Butterfly Valve – Supervised Open	22
FireLock Check Valve	23
FireLock Commercial Zone Control Riser Module	26
FireLock High Pressure Butterfly Valve – Supervised Closed	23
FireLock High Pressure Butterfly Valve – Supervised Open	22
FireLock High Pressure Check Valve	23
FireLock High Pressure Riser Check Valve	24
FireLock NRS Gate Valves	25
FireLock OS&Y Gate Valves	24
FireLock Residential Zone Control Riser Module	26
FireLock Riser Check Valve	24
FireLock Upright Post Indicator	27
FireLock Wall Post Indicator	27
FireLock Wye Type Vic-Strainer	28
Fire Pump Test Meter	28
TestMaster™ II Alarm Test Module	27

**Devices and Accessories**

Accessories Compatibility Chart	34
Air Maintenance/Compressor Assembly	35
Double Pneumatic Actuator	36
Electric/Pneumatic Double Interlock Actuator	35
FireLock NXT™ Alternate Wet/Dry System Check Valve – Europe Only	32
FireLock NXT Deluge System Check Valve	31
FireLock NXT Dry System Check Valve	31
FireLock NXT Preaction System Check Valve	31
FireLock NXT Preaction System with AutoConvert Assembly	32
FireLock 300PSI Solenoid	35
FireLock Air Maintenance Trim Assembly	38
FireLock Alarm Check Valve	32
FireLock Auto Drain	37
FireLock Ball Check Valve	36
FireLock Dry Accelerator	37
FireLock European Alarm Check Valve Station	33
FireLock Fire-Pac	33
FireLock Retard Chamber	38
Low Pressure Actuator	36
Manual Release Panel	37
Supplemental Alarm Kit	39
Water Column Drain Kit	38
Water Motor Alarm	39

**Automatic Sprinklers**

Accessories	54
Dry	51–52
Extended Coverage	45–46
Nozzles	53
Residential	49
Specific Application	50
Standard Commercial	43–44
Storage	47–48
Wrenches	54

**Victaulic Vortex™**

Victaulic Vortex 500 Fire Suppression System	56
Victaulic Vortex 1000 Fire Suppression System	56
Victaulic Vortex 1500 Fire Suppression System	56

**Specialty Systems**

AWWA Piping Systems for North America	60
Copper Piping System	59
HDPE Piping System	59
Plain End Piping System	58
Stainless Steel Piping System	60
Vic-Press™ for Schedule 10S Stainless Steel Piping	58

**Pipe Preparation Tools**

VE12 Groove In-Place	62
VE26 Groove In-Place	62
VE46 Groove In-Place	63
VE226 Portable Groover	64
VE206	65
VE106/VE107 Groove-N-Go	66
VE270FSD/VE271FSD	67
VE272SFS	68
VE416FSD/VE417FSD	69
VE268	70
VG28GD (Gear Drive)	71
VG Vic-Groover	71
PFT510	72
HCT908	72
VHCT900	73
VIC-TAP II	73
VPD752 Power Drive	74
Power Mule II	74
VAPS112 Adjustable Pipe Stand	75

## PRODUCT CERTIFICATIONS:

## Fire Protection

ACTIVFIRE – ActivFire Register of Fire Protection Equipment (Australia)
CCCF – China Certification Center for Fire Protection Products (China)
CFPSC – Chinese Fire Protection Safety Center (Taiwan)
CNBOP – Centrum Naukowo-Badawcze Ochrony Przeciwpozarowej (Poland)
CNPP- Centre National de Prévention et de Protection (France)
CTPC – Consiliul Technic Permanent Pentru Constructii (Romania)
cULus – Underwriter's Laboratories, LLC (USA)
EMI – Epitesugyi Minosegellenorzo Innovacious (Hungary)
FDNY – City of New York Fire Department (USA)
FM – FM Approvals (USA)
HDB – Singapore Housing Development Board (Singapore)
KFI – Korea Fire Industry Technology Institute (Korea)
LPCB – Loss Prevention Certification Board (UK)
SBSC – Svensk Brand & Säkerhets Certifiering AB (Sweden)
TFRI – Tanjin Fire Research Institute of Ministry of Public Security (China)
TSU – Technický Skúšobný Ústav Piešťany, š.p. (Slovakia)
TSUS – Technický Skúšobný Ústav Stavebný, n.o. (Slovakia)
TZUS – Technická a Zkušební Ústav Stavební Praha, s.p. (Czech Republic)
UKRFIRESERT – State Certification Center (Ukraine)
UL – Underwriter's Laboratories, LLC (USA)
ULC – Underwriter's Laboratories of Canada (Canada)
VdS – Verband der Schadenverhütung GmBH (Germany)
VKF – Vereinigung Kantonaler Feuerversicherungen (Switzerland)
Zagrebinspekt (Croatia)

## Potable Water

ÁNTSZ – Állami Népegészségügyi És Tisztiorvosi Szolgálat (Hungary)
ARPA – Agenzia Regionale per la Protezione dell'Ambiente (Italy)
DVGW – Deutscher Verein des Gas- und Wasserfaches e.V. (Germany)
Eurofins – ACS : Attestation de Conformité Sanitaire (France)
HZJZ – Croatian National Institute of Public Health (Croatia)
NSF – NSF International (USA)
ÖVGW – Österreichische Vereinigung für das Gas- und Wasserfach (Austria)
PZH – Panstwowy Zaklad Higieny (Poland)
RUVZPP – Regionálny úrad verejného zdravotníctva so sídlom v Poprade (Slovakia)
SAI – SAI Global (Australia)
SPAN – Suruhanjaya Perkhidmatan Air Negara (Malaysia)
SVGW – Schweizerischer Verein des Gas- und Wasserfaches (Sweden)
UL – Underwriter's Laboratories, LLC (USA)
WRAS – Water Regulations Advisory Scheme (UK)
ZUOVA – ZDRAVOTNÍ ÚSTAV se sídlem v Ostrave (Czech Republic)

## Maritime

ABS – American Bureau of Shipping (USA)
BV – Bureau Veritas (France)
CCG – Canadian Coast Guard (Canada)
CRS – Croatian Register of Shipping (Croatia)
CCS – China Classification Society (China)
DNV – Det Norske Veritas (Norway)
DNV GL (Global)
GL – Germanischer Lloyd (Germany)
KRS – Korean Registry of Shipping (Korea)
LR – Lloyd's Register of Shipping (UK)
RINA – Registro Italiano Navale (Italy)
USCG – US Coast Guard (USA)

## HVAC

CSTB - Centre Scientifique et Technique du Bâtiment (France)
ITB – Instytut Techniki Budowlanej (Poland)
Sercons Europe BV (Russia)
<b>Plumbing</b>
IAPMO – International Association of Plumbing & Mechanical Officials (USA)
ICC-ES – International Code Council- Evaluation Service (USA)
NSF – NSF International (USA)
WaterMark (Australia)

## COMPLIANCE:

## Codes/Standards

ANSI – American National Standards Institute (USA)
API – American Petroleum Institute (USA)
APSAD – Assemblée Plénière Société Assurance Dommage (France)
AS/NZS – Standards Australia and Standards New Zealand (AU & NZ)
ASTM – American Society for Testing and Materials (USA)
AWWA – American Water Works Association (USA)
BOCA – Building Officials and Code Administrators (USA)
CSA – Canadian Standards Association (Canada)
CSFM – California State Fire Marshal (USA)
EN – European Standards
GOST R – Gosstandart (Russia)
IPC – International Plumbing Code (USA)
ISO – International Standards Organization (Global)
NACE – National Association of Corrosion Engineers (USA)
NFPA – National Fire Protection Association (USA)
SBCCI – Southern Building Code Congress International (USA)
UPC – Uniform Plumbing Code (USA)

## Pressure Equipment Safety

(97/23/EC) PED – Pressure Equipment Directive (Europe)
CSA B51 – "Boiler, Pressure Vessel, and Pressure Piping Code" (Canada)
CRN – Canadian Registration Number per CSA B51 (Canada)

## Chemical Safety / Recycling

(EC/1907/2006) REACH– Registration, Evaluation, Authorization, and Registration of Chemicals (Europe)
(2002/95/EC) RoHS – Restriction of Hazardous Substances Directive (Europe)
(2002/96/EC) WEEE – Waste Electrical and Electronic Equipment Directive (Europe)

## Building Services

(EU/305/2011) CPR – Construction Products Regulation-Fire safety products (Europe)
NBC – National Building Code (Canada)
PSB – TUV SUD PSB Singapore (Singapore)

## Explosive Environments

(94/9/EC) ATEX – Equipment and protective systems for potentially explosive atmospheres (Europe)
--

## Seismic

OSHDP – Office of Statewide Health Planning and Development (USA)
---

## Tools and Machinery

(2006/42/EC) MD – Machinery Directive (Europe)
--

© Copyright 2015, Victaulic® Company. All rights reserved.

No part of this Victaulic catalog may be reproduced, stored in a retrieval system, or transmitted, in any form or by any means, electronic, mechanical, photocopy, recording or otherwise, without the prior written permission of Victaulic Company.

# VICTAULIC® WORLDWIDE

## North and South America

### UNITED STATES AND WORLD HEADQUARTERS

4901 Kesslersville Road  
Easton, PA 18040 USA  
1 800 PICK VIC  
1 800 742 5842  
(within North America)  
1 610 559 3300  
[pickvic@victaulic.com](mailto:pickvic@victaulic.com)

### CANADA

123 Newkirk Road  
Richmond Hill  
Ontario L4C 3G5 Canada  
1 905 884 7444  
[viccanada@victaulic.com](mailto:viccanada@victaulic.com)

### MEXICO

Calle Circuito del Marques  
No 8 al 11  
Parque Industrial El Marques  
Municipio El Marques  
Queretaro, Mexico  
CP 76246  
52 442 253 0066  
[vical@victaulic.com](mailto:vical@victaulic.com)

### BRAZIL

Av. Marquês de São Vicente  
446 Cj 1303  
Várzea da Barra Funda –  
São Paulo-SP  
CEP 01139-000 – Brazil  
55 11 3548 4280  
[vicbr@victaulic.com](mailto:vicbr@victaulic.com)

## Europe, Middle East, Africa and India

### BELGIUM

Prijkelstraat 36  
9810 Nazareth, Belgium  
32 9 381 15 00  
[viceuro@victaulic.com](mailto:viceuro@victaulic.com)

### UNITED KINGDOM

Units B1 & B2, SG1 Industrial Park  
Cockerell Close, Gunnels Wood Road  
Stevenage, Hertfordshire, UK  
SG 1 2NB  
44 1438 310 690  
[viceuro@victaulic.com](mailto:viceuro@victaulic.com)

### GERMANY

LOGICPARK  
Gutenbergstrasse 19  
D-64331 Weiterstadt, Germany  
49 6151 9573 0  
[viceuro@victaulic.com](mailto:viceuro@victaulic.com)

### UNITED ARAB EMIRATES

P.O. Box 17683, Unit XB 8  
Jebel Ali Free Zone  
Dubai, United Arab Emirates  
971 4 883 88 70  
[viceuro@victaulic.com](mailto:viceuro@victaulic.com)

### INDIA

India Land Global Industrial Park  
Plot 4, Hinjewadi, Phase-1, Mulshi  
Pune 411057, India  
91 20 67 919 300  
[viceuro@victaulic.com](mailto:viceuro@victaulic.com)

## Asia Pacific

### CHINA

Unit 808, Building B  
Hongwell International Plaza  
No.1602 West Zhongshan Road  
Shanghai, China 200235  
86 21 6021 9400  
[vicap@victaulic.com](mailto:vicap@victaulic.com)

### KOREA

4F, Seoil Building, 1430-5,  
Seocho-Dong, Seocho-Gu  
Seoul, Korea 137-070  
82 2 521 7235  
[vicap@victaulic.com](mailto:vicap@victaulic.com)

### TAIWAN

No. 55, NanGong Rd, LuJhu Township  
TaoYuan County, Taiwan 338  
886 3 222 3220  
[vicap@victaulic.com](mailto:vicap@victaulic.com)

### AUSTRALIA AND NEW ZEALAND

7 Chambers Road  
Unit 1  
Altona North, Victoria  
Australia 3025  
1 300 PIC VIC  
1 300 742 842  
(within Australia)  
0 508 PICK VIC  
0 508 7425 842  
(within New Zealand)  
61 3 9392 4000  
[vicaust@victaulic.com](mailto:vicaust@victaulic.com)

For additional locations, information and support, visit [victaulic.com/contactus](http://victaulic.com/contactus)

[victaulicfire.com](http://victaulicfire.com)



G-105 3567 REV G 04/2015

Victaulic and all other Victaulic marks are the trademarks or registered trademarks of Victaulic Company, and/or its affiliated entities, in the U.S. and/or other countries. All other trademarks listed herein are the property of their respective holders, in the U.S. and/or other countries. The terms "Patented" or "Patent Pending" refer to design or utility patents or patent applications for articles and/or methods of use in the United States and/or other countries.

© 2015 VICTAULIC COMPANY. ALL RIGHTS RESERVED.

