

Harco Fittings LLC SDR-35 PVC Gasketed Sewer Fittings

DESIGN DATA

Applicable Standards:

Fittings:	ASTM F-1336
Materials:	ASTM D-1784
Joints:	ASTM D-3212
Gaskets:	ASTM F-477
Installation:	ASTM D-2321

BELL SPECIFICATION

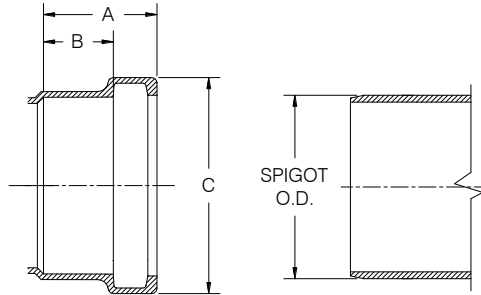

SIZE	STYLE	A	B	C	Spigot O.D.
4	M	2.72	1.8	5.19	4.215
6	M	3.47	2.5	7.38	6.275
8	M	4.02	3.0	9.62	8.40
10	F / M	7.5	4.8	12.0 / 12.2	10.50
12	F / M	7.5	4.8	14.2 / 14.4	12.50
15	F	7.5	4.8	17.1	15.3

DOUBLE WYE (G x G x G)

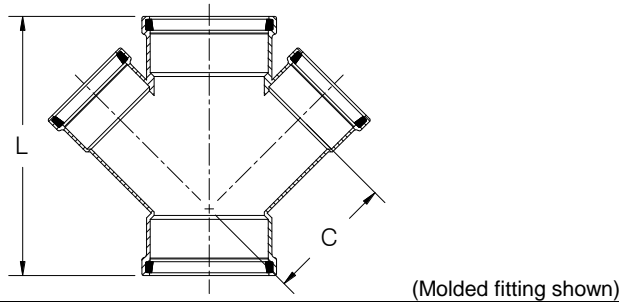

SIZE	PART #	STYLE	C	L	WT (approx.)
4	35-040404	F	5.2	11.8	3.0
6 x 4	35-040604	M	6.8	16.0	5.0
6	35-040606	M	8.0	16.0	8.0
8 x 4	35-040804	F	8.0	15.0	9.3
8 x 6	35-040806	F	9.2	18.5	11.9

Notes:

- All lay lengths & weights are approximate and are subject to change without notice
- Fabricated fitting configurations may vary

Style Legend:

M - One Piece Molded
 A - Assembled from Molded Components
 F - Fabricated
 FTO - Fabricated To Order

CAUTION: Vertical risers are not recommended
 Vertical risers are subject to problems without special consideration of soil/pipe interaction, dead & live loads, and installation procedures.

45° WYE (G x G x G)

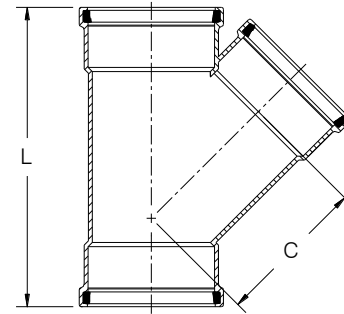

SIZE	PART #	STYLE	C	L	WT (approx.)
4	35-010404	M	5.2	11.8	2.4
6 x 4	35-010604	M	6.8	16.0	4.8
6	35-010606	M	8.0	16.0	5.6
8 x 4	35-010804	M	8.7	15.0	7.3
8 x 6	35-010806	M	9.2	18.5	9.4
8	35-010808	M	10.2	20.5	12.1
10 x 4	35-011004	A	12.5	26.0	14.0
10 x 6	35-011006	M	11.2	19.4	19.0
10 x 8	35-011008	F	13.8	31.5	20.0
10	35-011010	F	15.0	35.5	27.0
12 x 4	35-011204	A	13.8	27.0	21.0
12 x 6	35-011206	M	12.7	20.7	27.0
12 x 8	35-011208	F	15.1	32.5	28.0
12 x 10	35-011210	F	15.3	36.5	33.0
12	35-011212	F	18.1	39.5	44.0
15 x 4	35-011504	FTO	15.7	29.0	32.0
15 x 6	35-011506	F	15.7	32.0	36.0
15 x 8	35-011508	F	17.0	34.5	40.0
15 x 10	35-011510	FTO	18.2	38.5	50.0
15 x 12	35-011512	FTO	20.0	41.5	59.0
15	35-011515	FTO	22.0	46.0	66.0

45° WYE (G x S x G)

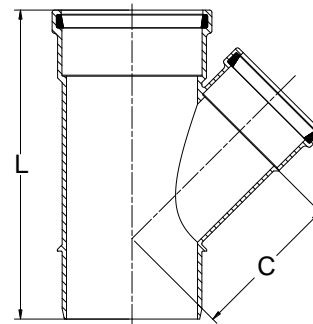

SIZE	PART #	STYLE	C	L	WT (approx.)
4	35-020404	M	5.2	11.8	2.0
6 x 4	35-020604	M	6.8	16.0	4.3
6	35-020606	M	8.0	16.0	5.4
8 x 4	35-020804	M	8.7	15.0	6.6
8 x 6	35-020806	M	9.2	18.5	8.5
8	35-020808	M	10.2	20.0	11.6

Call For Other Sizes, Configurations & Gasket Materials



Harco Fittings LLC

P.O. BOX 10335 • LYNCHBURG, VIRGINIA 24506 • 3721 COHEN PLACE • LYNCHBURG, VIRGINIA 24501
 PHONE: (434) 845-7094 • FAX: (434) 845-8562 • E-MAIL: sales@harcofittings.com • WEB: www.harcofittings.com

Harco Fittings LLC SDR-35 PVC Gasketed Sewer Fittings

DESIGN DATA

TEE (G x G x G)

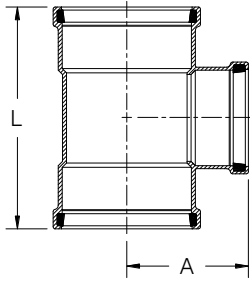

(Molded fitting shown)

SIZE	PART #	STYLE	A	L	WT (approx.)
4	35-120404	M	4.9	10.0	1.9
6 x 4	35-120604	M	5.9	11.7	3.9
6	35-120606	M	6.8	13.7	4.5
8 x 4	35-120804	M	7.0	13.0	7.0
8 x 6	35-120806	M	7.9	15.0	8.1
8	35-120808	M	8.6	17.9	9.4
10 x 4	35-121004	F	12.7	23.5	14.0
10 x 6	35-121006	F	13.2	25.2	16.0
10 x 8	35-121008	F	13.7	27.5	17.0
10	35-121010	F	15.2	29.5	23.0
12 x 4	35-121204	F	13.6	24.5	20.0
12 x 6	35-121206	F	14.1	26.5	23.0
12 x 8	35-121208	F	14.6	28.5	25.0
12 x 10	35-121210	F	16.1	30.5	29.0
12	35-121212	F	16.6	32.5	31.0
15 x 4	35-121504	F	15.0	26.5	31.0
15 x 6	35-121506	F	15.5	28.5	34.0
15 x 8	35-121508	F	16.0	30.5	36.0
15 x 10	35-121510	F	17.5	32.5	41.0
15 x 12	35-121512	F	18.0	34.5	45.0
15	35-121515	F	19.0	37.5	61.0

MANHOLE ADAPTERS (Double Bell)

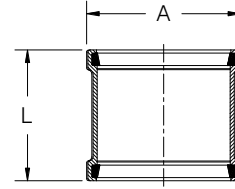

Note: Adapter has a sand coated exterior surface

(Molded fitting shown)

SIZE	PART #	STYLE	A	L	WT (approx.)
4	35-5704	M	5.6	5.6	0.9
6	35-5706	M	7.1	7.1	3.9
8	35-5708	M	8.3	8.3	7.1
10	35-5710	F	12.5	10.5	12.0
12	35-5712	F	13.5	11.5	16.0
15	35-5715	F	14.5	14.5	23.0

COUPLING (w/ Stop)

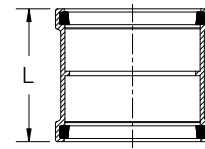

(Molded fitting shown)

SIZE	PART #	STYLE	L	WT (approx.)
4	35-0804	M	5.5	1.0
6	35-0806	M	7.1	2.2
8	35-0808	M	8.3	4.3
10	35-0810	F	13.5	6.0
12	35-0812	F	14.5	12.0
15	35-0815	F	17.0	22.0

REPAIR COUPLING (No Stop - Sleeve)

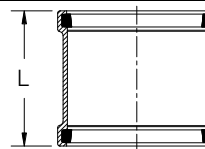

(Molded fitting shown)

SIZE	PART #	STYLE	L	WT (approx.)
4	35-0904	M	5.5	1.1
6	35-0906	M	7.1	2.2
8	35-0908	M	8.3	4.1
10	35-0910	F	10.5	7.0
12	35-0912	F	11.5	11.0
15	35-0915	F	14.5	17.0

MANHOLE ADAPTERS (Single Bell)

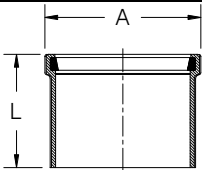

Note: Adapter has a sand coated exterior surface

(Molded fitting shown)

SIZE	PART #	STYLE	A	L	WT (approx.)
4	35-5804	M	5.2	4.3	1.3
6	35-5806	M	7.4	6.0	2.6
8	35-5808	M	9.6	7.0	4.6
10	35-5810	F	12.3	6.3	6.1
12	35-5812	F	14.5	6.8	9.1
15	35-5815	F	17.5	7.3	11.5

Notes:

- All lay lengths & weights are approximate and are subject to change without notice
- Fabricated fitting configurations may vary

Style Legend:

M - One Piece Molded
F - Fabricated

CAUTION: Vertical risers are not recommended
Vertical risers are subject to problems without special consideration of soil/pipe interaction, dead & live loads, and installation procedures.

CAP

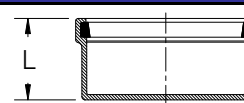

(Molded fitting shown)

SIZE	PART #	STYLE	L	WT (approx.)
4	35-4904	M	2.7	0.6
6	35-4906	M	3.5	1.4
8	35-4908	M	4.0	3.0
10	35-4910	F	10.5	8.0
12	35-4912	F	12.0	12.0
15	35-4915	F	14.0	23.0

Call For Other Sizes, Configurations & Gasket Materials



Harco Fittings LLC

P.O. BOX 10335 • LYNCHBURG, VIRGINIA 24506 • 3721 COHEN PLACE • LYNCHBURG, VIRGINIA 24501
PHONE: (434) 845-7094 • FAX: (434) 845-8562 • E-MAIL: sales@harcofittings.com • WEB: www.harcofittings.com

Harco Fittings LLC SDR-35 PVC Gasketed Sewer Fittings

DESIGN DATA

90° BEND (G x G)

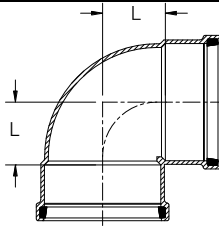

(Molded fitting shown)

SIZE	PART #	STYLE	L	WT (approx.)
4	35-1804	M	2.4	1.4
6	35-1806	M	3.5	3.3
8	35-1808	M	4.6	7.0
10	35-1810	F	9.0	21.0
12	35-1812	F	11.5	30.0
15	35-1815	F	12.5	52.0

90° BEND (G x S)

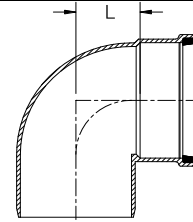

(Molded fitting shown)

SIZE	PART #	STYLE	L	WT (approx.)
4	35-1904	M	2.4	1.1
6	35-1906	M	3.5	2.8
8	35-1908	M	4.6	6.1
10	35-1910	F	9.0	19.0
12	35-1912	F	11.5	30.0
15	35-1915	F	12.5	50.0

45° BEND (G x G)

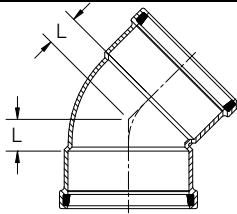

(Molded fitting shown)

SIZE	PART #	STYLE	L	WT (approx.)
4	35-2204	M	1.2	1.2
6	35-2206	M	1.6	2.8
8	35-2208	M	2.2	5.7
10	35-2210	F	3.3	16.0
12	35-2212	F	5.5	24.0
15	35-2215	F	5.5	38.0

45° BEND (G x S)

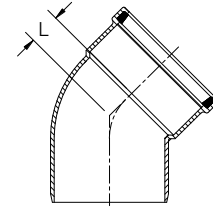

(Molded fitting shown)

SIZE	PART #	STYLE	L	WT (approx.)
4	35-2304	M	1.2	0.9
6	35-2306	M	1.6	2.3
8	35-2308	M	2.2	5.0
10	35-2310	F	3.3	15.0
12	35-2312	F	5.5	23.0
15	35-2315	F	5.5	31.0

22.5° BEND (G x G)

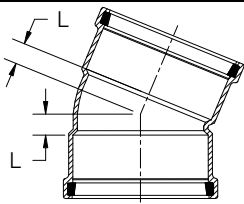

(Molded fitting shown)

SIZE	PART #	STYLE	L	WT (approx.)
4	35-2404	M	0.7	1.1
6	35-2406	M	1.1	2.6
8	35-2408	M	1.3	5.1
10	35-2410	F	2.0	16.0
12	35-2412	F	2.5	25.0
15	35-2415	F	4.8	40.0

22.5° BEND (G x S)

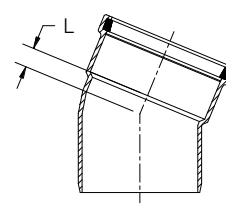

(Molded fitting shown)

SIZE	PART #	STYLE	L	WT (approx.)
4	35-2504	M	0.7	0.9
6	35-2506	M	1.1	2.1
8	35-2508	M	1.3	4.4
10	35-2510	F	2.0	15.0
12	35-2512	F	2.5	22.0
15	35-2515	F	4.8	33.0

Notes:

- All lay lengths & weights are approximate and are subject to change without notice
- Fabricated fitting configurations may vary

Style Legend:

M - One Piece Molded
F - Fabricated

Call For Other Sizes, Configurations & Gasket Materials

CAUTION: Vertical risers are not recommended
Vertical risers are subject to problems without special consideration of soil/pipe interaction, dead & live loads, and installation procedures.



Harco Fittings LLC

P.O. BOX 10335 • LYNCHBURG VIRGINIA 24506 • 3721 COHEN PLACE • LYNCHBURG VIRGINIA 24501
PHONE: (434) 845-7094 • FAX: (434) 845-8562 • E-MAIL: sales@harcofittings.com • WEB: www.harcofittings.com

Harco Fittings LLC SDR-35 PVC Gasketed Sewer Fittings

DESIGN DATA

TEE-WYE (G x G x G)

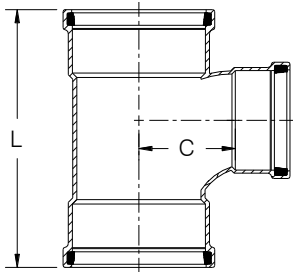

(Molded fitting shown)

SIZE	PART #	STYLE	C	L	WT (approx.)
4	35-050404	M	3.7	11.8	2.3
6 x 4	35-050604	M	4.6	15.5	4.6
6	35-050606	M	5.1	15.5	5.3
8 x 4	35-050804	M	5.6	14.2	6.8
8 x 6	35-050806	M	6.1	16.4	8.4
8	35-050808	M	6.3	17.8	9.6
10 x 4	35-051004	A	12.1	26.0	16.0
10 x 6	35-051006	M	7.0	17.9	17.0
12 x 4	35-051204	A	11.9	27.0	22.0
12 x 6	35-051206	M	8.0	19.0	24.0
15 x 4	35-051504	F	12.6	29.0	33.0
15 x 6	35-051506	F	15.8	32.0	41.0

PERMANENT PLUG

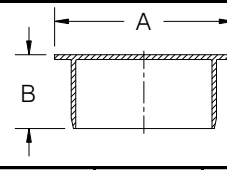

(Molded fitting shown)

SIZE	PART #	STYLE	A	B	WT (approx.)
4	35-4404	M	4.5	2.8	0.4
6	35-4406	M	6.7	3.7	1.1
8	35-4408	M	8.9	4.3	5.3
10	35-4410	F	11.1	6.0	7.0
12	35-4412	F	13.2	7.0	10.0
15	35-4415	F	16.2	9.0	17.0

TEMPORARY PLUG

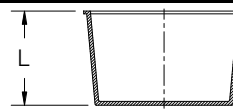

(Polyethylene)

SIZE	PART #	STYLE	L	WT (approx.)
4	35-4704	M	4.3	0.2
6	35-4706	M	3.8	0.3
8	35-4708	M	8.4	0.9

TEE-WYE (G x S x G)

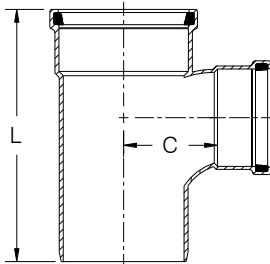

SIZE	PART #	STYLE	C	L	WT (approx.)
4	35-060404	M	3.7	11.8	2.0
6 x 4	35-060604	M	4.6	15.5	4.1
6	35-060606	M	5.1	15.5	4.5
8 x 4	35-060804	M	5.6	14.2	6.1
8 x 6	35-060806	M	6.1	16.4	7.6
8	35-060808	M	6.3	17.8	9.2

SADDLE WYE

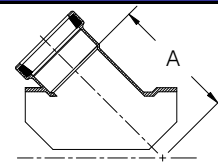

(Saddle gasket & SS straps not shown)

SIZE	PART #	STYLE	A	WT (approx.)
6 x 4	35-550604	M	8.9	1.4
8 x 4	35-550804	M	10.4	1.5
8 x 6	35-550806	M	12.0	3.3
10 x 4	35-551004	M	11.9	1.2
10 x 6	35-551006	M	13.0	3.3
12 x 4	35-551204	M	13.4	1.2
12 x 6	35-551206	M	14.3	3.8

SADDLE TEE

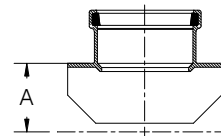

(Saddle gasket & SS straps not shown)

SIZE	PART #	STYLE	A	WT (approx.)
6 x 4	35-560604	M	3.3	1.0
8 x 4	35-560804	M	4.5	1.2
8 x 6	35-560806	M	4.7	2.4
10 x 4	35-561004	M	5.5	3.3
10 x 6	35-561006	M	5.7	2.3
12 x 4	35-561204	M	6.5	1.2
12 x 6	35-561206	M	6.6	3.1

Notes:

- All lay lengths & weights are approximate and are subject to change without notice
- Fabricated fitting configurations may vary

Style Legend:

- M - One Piece Molded
- A - Assembled from Molded Components
- F - Fabricated

CAUTION: Vertical risers are not recommended

Vertical risers are subject to problems without special consideration of soil/pipe interaction, dead & live loads, and installation procedures.

Call For Other Sizes, Configurations & Gasket Materials



Harco Fittings LLC

P.O. BOX 10335 • LYNCHBURG VIRGINIA 24506 • 3721 COHEN PLACE • LYNCHBURG VIRGINIA 24501
 PHONE: (434) 845-7094 • FAX: (434) 845-8562 • E-MAIL: sales@harcofittings.com • WEB: www.harcofittings.com

Harco Fittings LLC SDR-35 PVC Gasketed Sewer Fittings

DESIGN DATA

CONCENTRIC INCREASER (G x S)

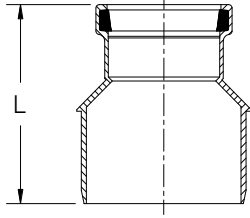

(Molded fitting shown)

SIZE	PART #	STYLE	L	WT (approx.)
4 x 6	35-160406	M	8.1	1.4
4 x 8	35-160408	F	9.1	2.7
4 x 10	35-160410	F	13.2	7.5
4 x 12	35-160412	F	13.5	11.0
4 x 15	35-160415	FTO	15.0	19.0
6 x 8	35-160608	M	9.0	3.0
6 x 10	35-160610	F	13.3	7.0
6 x 12	35-160612	F	13.6	13.0
6 x 15	35-160615	FTO	14.8	17.0
8 x 10	35-160810	F	13.4	9.0
8 x 12	35-160812	F	13.7	12.0
8 x 15	35-160815	FTO	14.9	19.0
10 x 12	35-161012	F	22.0	16.0
10 x 15	35-161015	FTO	21.8	21.0
12 x 15	35-161215	F	24.5	24.0

CLEAN-OUT PLUG (RAISED)

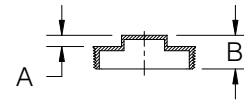

(Molded fitting shown)

SIZE	PART #	A	B	WT (approx.)
4	35-6104	0.5	1.5	0.2
6	35-6106	0.5	1.5	0.5

CLEAN-OUT PLUG (RECESSED)

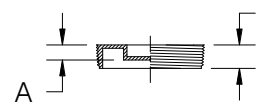

(Molded fitting shown)

SIZE	PART #	A	L	WT (approx.)
4	35-6204	0.7	1.0	0.2
6	35-6206	0.7	1.0	0.6

CLEAN-OUT ADAPTER (HUB)

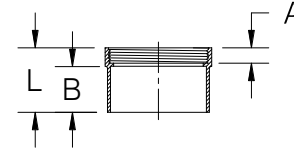

(Molded fitting shown)

SIZE	PART #	A	B	L	WT (approx.)
4	35-5904	1.0	1.8	2.9	0.5
6	35-5906	1.0	3.0	4.2	0.9

CLEAN-OUT ADAPTER (SPIGOT)

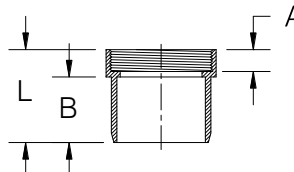

(Molded fitting shown)

SIZE	PART #	A	B	L	WT (approx.)
4	35-6004	1.0	1.8	7.1	0.6
6	35-6006	1.0	3.0	8.4	0.9

ADAPTER - Sewer x DWV (S x S)

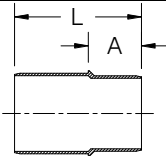

SIZE	PART #	STYLE	A	L	WT (approx.)
4	35-4004	M	2.8	6.9	1.5
6	35-4006	M	3.5	8.1	2.9

ADAPTER - Sewer x DWV (S x G)

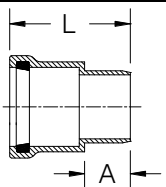

SIZE	PART #	STYLE	A	L	WT (approx.)
4	35-3504	M	2.7	7.1	1.6
6	35-3506	M	3.5	8.4	3.7

NOTES:

- All lay lengths & weights are approximate and are subject to change without notice
- Fabricated fitting configurations may vary

Style Legend:

M - One Piece Molded
 F - Fabricated
 FTO - Fabricated To Order

CAUTION: Vertical risers are not recommended
 Vertical risers are subject to problems without special consideration

Call For Other Sizes, Configurations & Gasket Materials

2-WAY CLEAN-OUT TEE

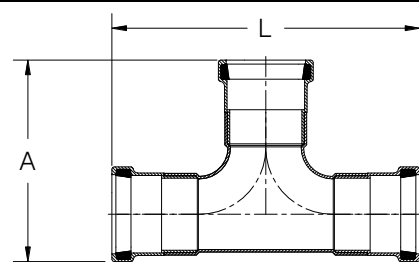

SIZE	PART #	STYLE	A	L	WT (approx.)
4	35-1304	F	11.0	16.9	3.0



Harco Fittings LLC

P.O. BOX 10335 • LYNCHBURG VIRGINIA 24506 • 3721 COHEN PLACE • LYNCHBURG VIRGINIA 24501
 PHONE: (434) 845-7094 • FAX: (434) 845-8562 • E-MAIL: sales@harcofittings.com • WEB: www.harcofittings.com