

Harco Fittings LLC SDR-26 PVC Gasketed Sewer Fittings

DESIGN DATA

Applicable Standards:

Fittings:	ASTM F-1336
Materials:	ASTM D-1784
Joints:	ASTM D-3212
Gaskets:	ASTM F-477
Installation:	ASTM D-2321

BELL SPECIFICATION

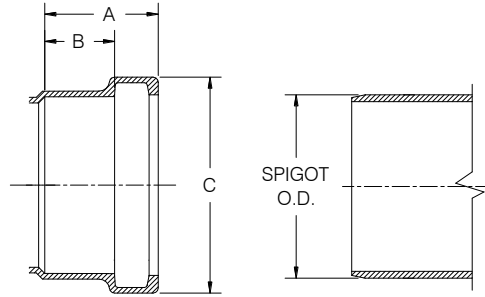

SIZE	STYLE	A	B	C	Spigot O.D.
4	M	2.72	1.8	5.18	4.215
6	M	3.47	2.5	7.37	6.275
8	M	4.02	3.0	9.62	8.40
10	F / M	7.5	4.8	12.0 / 12.2	10.50
12	F / M	7.5	4.8	14.2 / 14.4	12.50
15	F	7.5	4.8	17.1	15.3

DOUBLE WYE (G x G x G)

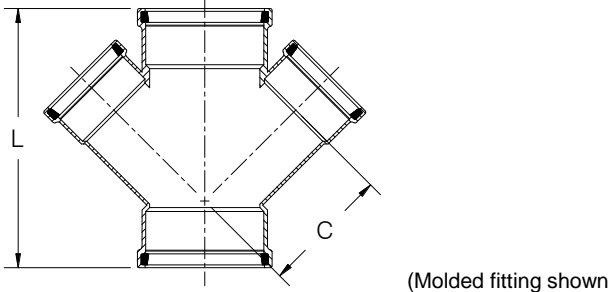

SIZE	PART #	STYLE	C	L	WT (approx.)
4	26-040404	FTO	5.2	11.8	3.0
6 x 4	26-040604	M	7.1	16.0	5.6
6	26-040606	M	7.8	17.0	9.3
8 x 4	26-040804	FTO	8.0	15.0	9.0
8 x 6	26-040806	FTO	9.2	18.5	12.0

Notes:

- All lay lengths & weights are approximate and are subject to change without notice
- Fabricated fitting configurations may vary

Style Legend:

- M - One Piece Molded
- A - Assembled from Molded Components
- F - Fabricated
- FTO - Fabricated To Order

CAUTION: Vertical risers are not recommended. Vertical risers are subject to problems without special consideration of soil/pipe interaction, dead & live loads, and installation procedures.

TEE-WYE (G x G x G)

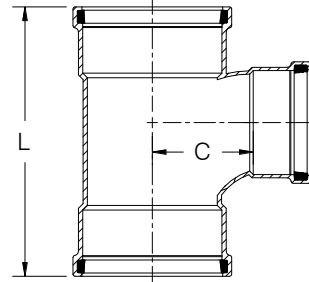

(Molded fitting shown)

SIZE	PART #	STYLE	C	L	WT (approx.)
4	26-050404	A	4.0	21.1	2.4
6 x 4	26-050604	A	5.2	21.6	2.6
6	26-050606	A	5.2	23.7	6.0
8 x 4	26-050804	M	5.5	16.6	9.9
8 x 6	26-050806	M	6.1	16.6	10.7
8	26-050808	F	15.0	23.6	17.0
10 x 4	26-051004	A	13.8	26.0	20.0
10 x 6	26-051006	M	7.0	17.9	17.0
12 x 4	26-051204	A	14.7	27.0	28.0
12 x 6	26-051206	M	8.0	19.0	24.0
15 x 4	26-051504	FTO	16.1	29.0	40.0
15 x 6	26-051506	FTO	16.5	32.0	42.0

TEE (G x G x G)

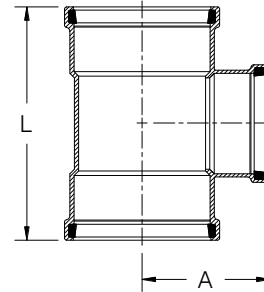

(Molded fitting shown)

SIZE	PART #	STYLE	A	L	WT (approx.)
4	26-120404	F	7.0	13.3	3.0
6 x 4	26-120604	F	8.0	14.0	5.0
6	26-120606	F	9.5	18.3	7.0
8 x 4	26-120804	M	10.5	19.3	10.0
8 x 6	26-120806	M	10.5	22.3	10.0
8	26-120808	F	12.7	25.5	14.0
10 x 4	26-121004	F	12.7	23.5	18.0
10 x 6	26-121006	FTO	13.2	25.5	20.0
10 x 8	26-121008	FTO	13.7	27.5	23.0
10	26-121010	FTO	15.2	29.5	29.0
12 x 4	26-121204	FTO	13.6	24.5	27.0
12 x 6	26-121206	FTO	14.1	26.5	28.0
12 x 8	26-121208	FTO	14.6	28.5	32.0
12 x 10	26-121210	FTO	16.1	30.5	38.0
12	26-121212	FTO	16.6	32.5	43.0
15 x 4	26-121504	FTO	15.0	26.5	38.0
15 x 6	26-121506	FTO	15.8	28.5	37.0
15 x 8	26-121508	FTO	16.0	30.5	46.0
15 x 10	26-121510	FTO	17.5	32.5	51.0
15 x 12	26-121512	FTO	18.0	34.5	57.0
15	26-121515	FTO	19.0	37.5	77.0

Call For Other Sizes, Configurations & Gasket Materials



Harco Fittings LLC

P.O. BOX 10335 • LYNCHBURG VIRGINIA 24506 • 3721 COHEN PLACE • LYNCHBURG VIRGINIA 24501
 PHONE: (434) 845-7094 • FAX: (434) 845-8562 • E-MAIL: sales@harcofittings.com • WEB: www.harcofittings.com

Harco Fittings LLC SDR-26 PVC Gasketed Sewer Fittings

DESIGN DATA

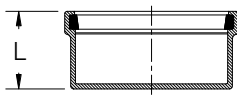
CAP					
 (Molded fitting shown)					
SIZE	PART #	STYLE	L	WT (approx.)	
4	26-4904	M	2.7	1.2	
6	26-4906	M	3.5	2.5	
8	26-4908	FTO	4.0	6.0	
10	26-4910	FTO	10.5	11.0	
12	26-4912	FTO	12.0	18.0	
15	26-4915	FTO	14.0	27.0	

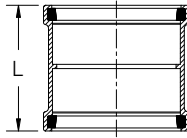
COUPLING (w/ Stop)					
 (Molded fitting shown)					
SIZE	PART #	STYLE	L	WT (approx.)	
4	26-0804	M	8.5	1.1	
6	26-0806	M	7.1	3.0	
8	26-0808	M	8.3	4.4	
10	26-0810	FTO	17.0	13.0	
12	26-0812	FTO	17.5	20.0	
15	26-0815	FTO	19.5	33.0	

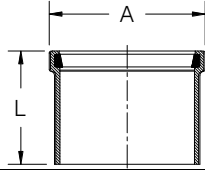
MANHOLE ADAPTER (Single Bell)					
					
SIZE	PART #	STYLE	A	L	WT (approx.)
4	26-5804	FTO	5.2	4.3	0.7
6	26-5806	FTO	7.4	6.0	1.6
8	26-5808	FTO	9.6	7.0	3.4
10	26-5810	FTO	12.3	6.3	6.2
12	26-5812	FTO	14.5	6.8	9.2
15	26-5815	FTO	17.5	7.3	15.9

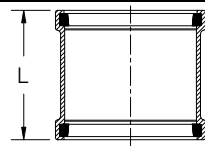
REPAIR COUPLING (No Stop - Sleeve)					
 (Molded fitting shown)					
SIZE	PART #	STYLE	L	WT (approx.)	
4	26-0904	M	8.5	1.1	
6	26-0906	M	6.7	2.0	
8	26-0908	M	8.3	5.3	
10	26-0910	F	12.5	9.0	
12	26-0912	F	13.5	14.0	
15	26-0915	FTO	14.5	22.0	

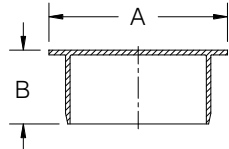
PERMANENT PLUG					
 (Molded fitting shown)					
SIZE	PART #	STYLE	A	B	WT (approx.)
4	26-4404	M	4.5	2.8	0.2
6	26-4406	M	6.7	3.7	2.5
8	26-4408	M	8.9	4.3	2.3
10	26-4410	FTO	11.1	6.0	9.0
12	26-4412	FTO	13.2	7.0	15.0
15	26-4415	FTO	16.2	9.0	25.0

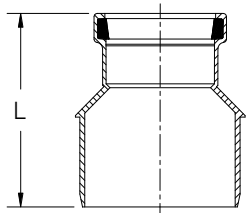
CONCENTRIC INCREASER (G x S)					
 (Molded fitting shown)					
SIZE	PART #	STYLE	L	WT (approx.)	
4 x 6	26-160406	M	11.8	3.0	
4 x 8	26-160408	FTO	12.0	2.7	
4 x 10	26-160410	FTO	18.5	11.0	
4 x 12	26-160412	FTO	18.5	16.0	
4 x 15	26-160415	FTO	19.3	26.0	
6 x 8	26-160608	FTO	13.0	2.6	
6 x 10	26-160610	FTO	19.0	12.0	
6 x 12	26-160612	FTO	19.0	16.0	
6 x 15	26-160615	FTO	19.8	26.0	
8 x 10	26-160810	FTO	20.5	12.0	
8 x 12	26-160812	FTO	19.5	18.0	
8 x 15	26-160815	FTO	20.3	28.0	
10 x 12	26-161012	FTO	22.0	18.0	
10 x 15	26-161015	FTO	21.8	29.0	
12 x 15	26-161215	FTO	24.5	31.0	

Notes:

- All lay lengths & weights are approximate and are subject to change without notice
- Fabricated fitting configurations may vary

Style Legend:

M - One Piece Molded
 F - Fabricated
 FTO - Fabricated To Order

CAUTION: Vertical risers are not recommended
 Vertical risers are subject to problems without special consideration of soil/pipe interaction, dead & live loads, and installation procedures.

Call For Other Sizes, Configurations & Gasket Materials



Harco Fittings LLC

P.O. BOX 10335 • LYNCHBURG VIRGINIA 24506 • 3721 COHEN PLACE • LYNCHBURG VIRGINIA 24501
 PHONE: (434) 845-7094 • FAX: (434) 845-8562 • E-MAIL: sales@harcofittings.com • WEB: www.harcofittings.com

Harco Fittings LLC SDR-26 PVC Gasketed Sewer Fittings

DESIGN DATA

90° BEND (G x G)

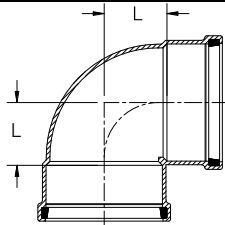

(Molded fitting shown)

SIZE	PART #	STYLE	L	WT (approx.)
4	26-1804	F	6.5	3.5
6	26-1806	M	3.7	4.2
8	26-1808	M	4.5	12.0
10	26-1810	F	9.0	21.0
12	26-1812	F	11.5	40.0
15	26-1815	FTO	12.5	73.0

90° BEND (G x S)

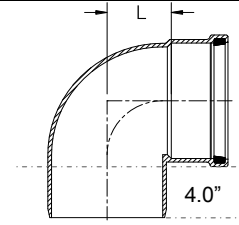

(Molded fitting shown)

SIZE	PART #	STYLE	L	WT (approx.)
4	26-1904	F	6.5	3.0
6	26-1906	M	3.7	3.6
8	26-1908	M	4.5	12.0
10	26-1910	FTO	9.0	19.0
12	26-1912	FTO	11.5	38.0
15	26-1915	FTO	12.5	66.0

45° BEND (G x G)

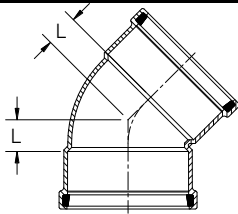

(Molded fitting shown)

SIZE	PART #	STYLE	L	WT (approx.)
4	26-2204	M	1.2	1.5
6	26-2206	M	1.6	2.8
8	26-2208	M	3.0	8.0
10	26-2210	F	3.3	16.0
12	26-2212	F	5.5	30.0
15	26-2215	FTO	5.5	48.0

45° BEND (G x S)

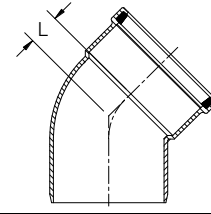

(Molded fitting shown)

SIZE	PART #	STYLE	L	WT (approx.)
4	26-2304	M	1.2	1.1
6	26-2306	M	1.6	2.9
8	26-2308	M	3.0	8.0
10	26-2310	F	3.3	15.0
12	26-2312	F	5.5	28.0
15	26-2315	FTO	5.5	48.0

22.5° BEND (G x G)

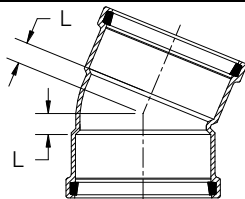

(Molded fitting shown)

SIZE	PART #	STYLE	L	WT (approx.)
4	26-2404	M	0.8	1.3
6	26-2406	M	1.2	3.2
8	26-2408	F	1.0	8.0
10	26-2410	FTO	2.0	16.0
12	26-2412	FTO	2.5	25.0
15	26-2415	FTO	4.8	51.0

22.5° BEND (G x S)

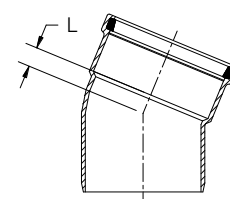

(Molded fitting shown)

SIZE	PART #	STYLE	L	WT (approx.)
4	26-2504	M	0.8	1.0
6	26-2506	M	1.2	2.7
8	26-2508	FTO	1.0	8.0
10	26-2510	FTO	2.0	15.0
12	26-2512	FTO	2.5	30.0
15	26-2515	FTO	4.8	33.0

Notes:

- All lay lengths & weights are approximate and are subject to change without notice
- Fabricated fitting configurations may vary

Style Legend:

M - One Piece Molded
 F - Fabricated
 FTO - Fabricated To Order

Call For Other Sizes, Configurations & Gasket Materials

CAUTION: Vertical risers are not recommended
 Vertical risers are subject to problems without special consideration of soil/pipe interaction, dead & live loads, and installation procedures.



Harco Fittings LLC

P.O. BOX 10335 • LYNCHBURG VIRGINIA 24506 • 3721 COHEN PLACE • LYNCHBURG VIRGINIA 24501
 PHONE: (434) 845-7094 • FAX: (434) 845-8562 • E-MAIL: sales@harcofittings.com • WEB: www.harcofittings.com

Harco Fittings LLC SDR-26 PVC Gasketed Sewer Fittings

DESIGN DATA

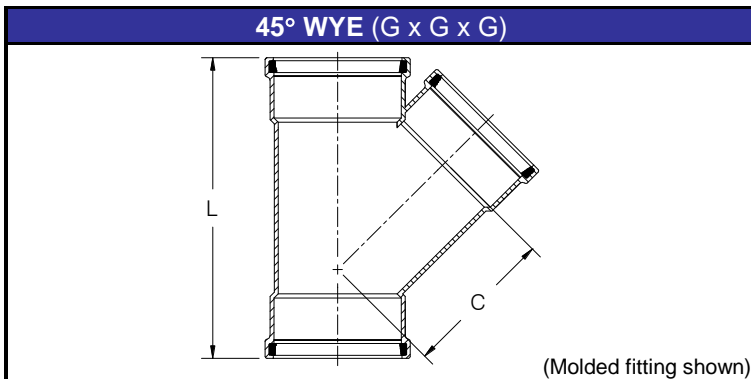

SIZE	PART #	STYLE	C	L	WT (approx.)
4 x 4	26-010404	M	5.1	11.8	2.5
6 x 4	26-010604	M	7.1	16.0	4.9
6 x 6	26-010606	M	7.6	16.0	7.0
8 x 4	26-010804	M	8.0	15.0	10.3
8 x 6	26-010806	M	9.3	18.5	11.4
8 x 8	26-010808	F	18.9	29.5	18.0
10 x 4	26-011004	A	17.0	26.0	19.0
10 x 6	26-011006	M	11.2	19.4	19.0
10 x 8	26-011008	FTO	20.3	31.5	26.0
10 x 10	26-011010	FTO	22.5	35.5	33.0
12 x 4	26-011204	A	18.3	27.0	27.0
12 x 6	26-011206	M	12.7	20.7	27.0
12 x 8	26-011208	FTO	21.6	32.5	30.0
12 x 10	26-011210	FTO	22.8	36.5	45.0
12 x 12	26-011212	FTO	25.6	39.5	58.0
15 x 4	26-011504	FTO	20.2	29.0	42.0
15 x 6	26-011506	FTO	21.5	32.0	45.0
15 x 8	26-011508	FTO	23.5	34.5	53.0
15 x 10	26-011510	FTO	25.7	38.5	64.0
15 x 12	26-011512	FTO	27.5	41.5	76.0
15 x 15	26-011515	FTO	30.2	46.0	88.0

Call For Other Sizes, Configurations & Gasket Materials

Notes:

- All lay lengths & weights are approximate and are subject to change without notice
- Fabricated fitting configurations may vary

Style Legend:

M - One Piece Molded
 A - Assembled from Molded Components
 F - Fabricated
 FTO - Fabricated To Order

CAUTION: Vertical risers are not recommended
 Vertical risers are subject to problems without special consideration
 of soil/biote interaction. dead & live loads. and installation procedures.



Harco Fittings LLC

P.O. BOX 10335 • LYNCHBURG VIRGINIA 24506 • 3721 COHEN PLACE • LYNCHBURG VIRGINIA 24501
 PHONE: (434) 845-7094 • FAX: (434) 845-8562 • E-MAIL: sales@harcofittings.com • WEB: www.harcofittings.com