

— Packing and Gasket Material — Gasket Fabrication — Stripping and Adhesive Backing — Spiral Wound Gaskets — Mechanical Seal Components — Standard O-Rings — Metric O-Rings — O-Ring Kits — O-Ring Cord — Vulcanizing — Custom Rubber Fabrication — Hydraulic Seals — Pressure Gauges — Industrial Hose Couplings — Clamping and Banding Systems — Industrial Glass — Glass Fabrication — Plastic Products — Adhesives and Sealants —



Packing and Gasket Catalog

www.callapg.com

713-675-5271
1-800-888-5223

FAX 713-675-2730
FAX 1-800-444-3252



“America’s Most Responsive Warehouse”

www.callapg.com

(713) 675-5271

1-800-888-5223

[email info@callapg.com](mailto:info@callapg.com)

FAX: (713) 675-2730

FAX: 1-800-444-3252

P.O. Box 213 (77001)

6039 Armour Dr. (77020)

Houston, Texas



Table of Contents

Product Index2

Style Number Index4

Custom Fabrication7

Standard Fabricated Products9

Spiral Wound Gaskets13

Braided Packing and Related Products16

Packing and Gasket Tools23

Sheet Materials and Tapes28

 Non-Asbestos Gasket Materials28

 Thermoseal Inc. Non-Asbestos Gasket Materials29

 Garlock Sealing Technologies Non-Asbestos Gasket Materials42

 Interface Solutions, Amorim Industrial Solutions, and Day International
 Non-Asbestos Gasket Materials45

 CHR Products49

 Sheet Materials - Elastomers54

 Other Sheet Materials and Tapes60

O-Ring Cord Stock and Extrusions67

Other APG Products listed on pages 71 and 72.



Product Index

Adhesive (Double with Release Liner)	63	Fiberglass Rope and Wick Packings	21
Allpax Extension Gasket Cutter	24	Fiberglass Tape	64
Amorim Industrial Solutions Non-Asbestos Gasket Materials	45, 46	Fiberglass Tape (Drop Warp)	64
Aramid Filament Packing	17	Fibrecork Sheet Material	65
Arch Punches, Osborne	25,26	Filled PTFE Sheet Material	44,60
BLUE-GARD® Non-Asbestos Gasket Materials	42,43	Fish Paper	66
Bluetex Vellum (White)	66	Flange Gaskets	9,10
Braided Inconel Wire Inserted Carbon Yarn over Plastic Core	17	Flange Protectors	10
Braided Packing	16-21	Flange Sealants	22
Buna-N Sheet Material	55,56	Flexible Graphite Packing	16
Butyl Sheet Material	57	Flexible Graphite Sheet Materials	61
Carbon Fiber with Graphite Coating Packing	18	Fluoroelastomer Sheet Material	57
Carbon Filament Impregnated with PTFE Packing	19	Folded Non-Asbestos Tape	64
Carbon Filament/TFE Packing	18	Garco Packing Tools	24
Chemical Resistance Chart (KLINGER®sil Products)	39-41	Garlock Non-Asbestos Gasket Materials	42-44
Chime Gaskets	11	Gasket Cutter, Allpax Extension	24
CHR Products	49-52	Gasket Cutter, Osborne	25
Cloth Inserted Black Rubber Sheet Material	58	“G.F.O.®” Packing	17
COHR Products (CHR)	51,52	Glass Filled TFE Sheet	44,60
Condenser Gaskets	11	Grafoil® Sheet Materials	61
Cord Packing	19	Gylon® Filled PTFE Gasket Materials	44
Cord Stock (O-Ring)	67-70	Graphite Filament Packing	18
Cork Sheet Material	45,46,65	Handhole Gaskets	12
Corrugated Vinyl Matting	62	Hooks, Packing	23,24
Cutters, Gasket	24,25	Hypalon Sheet Material	62
Daikin PCTFE Sheet	66	Impervapac (Interface Solutions) Gasket Material	46
Day International Non-Asbestos Gasket Materials	46	Interface Solutions Non-Asbestos Gasket Materials	45-48
Diaphragms	58	Kapton® Temp-R-Tape (CHR)	51
Die Library	7	Klinger Non-Asbestos Gasket Materials	29-38
Die-Making	7	KLINGER®sil Chemical Resistance Chart	39-41
Dome Gaskets	11	KLINGER®sil Non-Asbestos Gasket Materials	29-38
Drop Warp Fiberglass Tape	64	Knife, Osborne Square Point Utility	25
Dry Woven Fiberglass Cloth	63	Koroseal® Sheet Material	62
Durlon® 9000 Filled PTFE Gasket Material	60	Lap Gaskets	11
EPR (Peroxide Cured) Sheet Material	57	Lead Core Fiberglass Tacky Cloth Packing	65
EPR Sheet Material	57	Leather Sheet Material	63
Extension Gasket Cutter, Allpax	24	Lubricated PTFE Filament (Food Grade) Packing	19
Extrusions	67-70	Mayhew Hollow Punch Tool Kit	26
Felt Sheet Material	62	Manhole Gaskets	12
Fiberglass Cloth	63	Mica Sheet Material	66
Fiberglass Reinforced Silicone Rubber (CHR)	52	Neoprene Sheet Material	54,55
		Nomex® Aramid Paper	66



Product Index

Non-Asbestos Gasket Materials	.28	Tank Bolt Washers	.11
Novoloid Fiber/PTFE Impregnated Packing	.16	Tank Flange Gaskets	.11
“O” Ring Bulb-Type Gaskets	.12	Tank Strips	.11
O-Ring Cord Stock	.67-70	Teflon® Cord Packing	.19
Osborne Arch Punches	.25,26	Temp-R-Glas® Fabrics (CHR)	.49
Osborne Gasket and Washer Cutter	.25	Temp-R-Glas® Tape (CHR)	.50
Osborne Packing and Gasket Tools	.23-26	Temp-R-Tape® (CHR)	.50,51
Osborne Self-Centering Punch Kit	.25	TFE Filament Packing	.19
Osborne Utility Knife	.25	TFE Impregnated Non-Asbestos Packing	.16
Packing and Gasket Tools	.23-26	TFE Sheet Material	.44,60
Packing Hooks	.23,24	TFE Thread Sealant Tape	.22
Packing Screws	.23,24	Thermo-Tork (Interface Solutions) Gasket Materials	.48
Paper, Fish	.66	Thermoseal, Inc. Non-Asbestos Gasket Materials	.29-38
Peroxide Cured EPR Sheet Material	.57	Thief Hatch Gaskets	.11
Pipe Flange Gaskets	.9,10	Thread Sealant Tape	.22
Plant Fibre Sheet	.65	Tools	.23-26
PTFE Filament Impregnated with PTFE Packing	.19	Tools, Garco Packing	.24
PTFE Flange Sealants	.22	Tools, Mayhew Hollow Punch	.26
PTFE Impregnated Flax Packing	.20	Tools, Osborne Packing and Gasket	.23-26
Punches	.25,26	Tools, Packing	.23,24
Pure Gum Rubber Tan Floating Stock	.56	Twisted Fiberglass Rope Packing	.21
Radii Gaskets	.11	Twisted Fiberglass Wick Packing	.21
Radii Strip	.11	Utility Knife, Osborne Square Point	.25
Red Rubber Sheet Material	.54	Vegetable Fiber Packing	.20
Red Vulcanized Fiber	.65	Vellum (White Bluetex)	.66
Screws, Packing	.23,24	Vinyl Matting	.62
Sealex PTFE and Flange Sealant	.22	Vulcanized Fiber	.65
Shim Stock	.21	White Bluetex Vellum	.66
Silicone Sponge Rubber	.59		
Silicone Sponge Rubber (CHR)	.52		
Silicone Rubber Sheet Material	.57,58		
Silicone Solid Rubber (CHR)	.51,52		
Spiral Wound Gaskets	.13-15		
Sponge Sheet Material	.59		
Square Braided Non-Asbestos Graphited Packing	.17		
Strip-N-Stick® (CHR)	.49		
Stripping	.8,11		
Syntheseal (Interface Solutions) Gasket Material	.47		
Tacky Cloth (Fiberglass)	.63		
Tadpole Tape	.64		
Tallow Lubricated Flax Packing	.20		



Style Number Index

Style No.	Description	Page No.	Style No.	Description	Page No.
0281	Aflas® O-Ring Cord 75 Durometer67	0729H	Silicone Rubber 70 Durometer58
0282	EPDM (EPR) O-Ring Cord 70 Durometer67	0729S	Silicone Rubber 40 Durometer57
0283	Fluoroelastomer O-Ring Cord 75 Durometer .	.67	0729W	Silicone Rubber (White) 60 Durometer58
0283H	Fluoroelastomer O-Ring Cord 90 Durometer .	.67	0730	Cloth Inserted Black Rubber 60 Durometer . .	.58
0283VB	Brown Fluoroelastomer O-Ring Cord 75 Durometer68	0731M	Silicone Sponge Medium Density59
0284	Buna-N O-Ring Cord 70 Durometer68	0732	Corrugated Vinyl Matting62
0284H	Buna-N O-Ring Cord 90 Durometer68	0734	Cloth Finish Neoprene55
0285	Neoprene O-Ring Cord 70 Durometer68	0734C4X30	Chime or Lap Gaskets - 2 1/2' Lengths11
0286	Silicone O-Ring Cord 70 Durometer69	0734H	Neoprene 72 Durometer55
0286T	Silicone Tubing 70 Durometer69	0734R	Radii Strip11
0287	Closed Cell Neoprene Sponge Cord69	0734W	Neoprene (White) 72 Durometer55
0292	60 Durometer EPR Extrusion69	0735	Cloth Finish Buna-N56
0293	70 Durometer Fluoroelastomer Extrusion69	0741	Neoprene Duck Inserted Diaphragm58
0294	60 Durometer Silicone Extrusion69	0742	Neoprene Nylon Inserted Diaphragm58
0295W	60 Durometer White Neoprene Extrusion69	0743	Buna-N Nylon Inserted Diaphragm58
0296	Buna-N O-Ring Cord 70 Durometer (Square) .	.69	0747	Orange or Black Leather63
0297	Fluoroelastomer Square/Rectangular Cord 75 Durometer.69	0748	Tan Leather Hides63
0700	Red Rubber Smooth Finish 75 Durometer54	0759CCE	Closed Cell Nitrile PVC Sponge59
0710	Red Rubber Cloth Finish54	0760	Rubber Sponge Medium Density59
0716	Pure Gum Rubber Tan Floating Stock56	0760T	Rubber Sponge Medium Density (Tan)59
0718	Koroseal® 75 Durometer62	0761	Double Adhesive with Release Liner63
0721	Hypalon62	0762	Non-Asbestos, Wire-Inserted, Fiberglass Tacking Cloth63
0722	Fluoroelastomer, Premium Grade Plate Finish 70 Durometer57	0763	Dry Woven Fiberglass Cloth63
0723	EPR 60 Durometer57	0764	Fiberglass Cloth63
0723P	EPR Peroxide Cured 60 Durometer57	0775	Red Vulcanized Fibre65
0723S	EPR 40 Durometer57	0777	Fibrecork Sheet65
0725	Neoprene 60 Durometer54	0778	Fish Paper66
0725H	Neoprene 70 Durometer55	0780	Plant Fibre Sheet65
0725N	Neoprene 70 Durometer - Cloth Finish55	0781	White Bluetex Vellum66
0725S	Neoprene 40 Durometer54	0782	Plant Fibre Rubber Beater Saturated (Interface Solutions CS-301)45
0726	Buna-N 60 Durometer55	0783	Plant Fibre Buna-N Beater Saturated (Interface Solutions CN-705)45
0726H	Buna-N 90 Durometer56	0790	Fine Grain Cork65
0726P	High Grade Buna-N 60 Durometer56	0792	Cork and Neoprene Medium Hardness (Interface Solutions DC-100)45
0726S	Buna-N 50 Durometer55	0792A	Cork and Neoprene Soft (Interface Solutions DC-179)45
0726T	Buna-N 70 Durometer for Transformer Gaskets and Strip56	0793	Cork and Buna-N Medium Hardness (Interface Solutions NC-710)46
0726W	Buna-N White 50-65 Durometer56	0793B	Cork and Buna-N Firm (Interface Solutions NC-711)46
0728	Butyl 60 Durometer57			
0729	Silicone Rubber 50 Durometer57			



Style Number Index

Style No.	Description	Page No.	Style No.	Description	Page No.
0794	Cork and Synthetic Sponge Rubber, Adhesive Backed (Interface Solutions DK-153T)46	0KC4500	KLINGER®sil C-450034
0794FC	Cork and Synthetic Sponge Rubber, Adhesive Backed (Interface Solutions DK-153T)46	0KC4509	KLINGER®sil C-450934
0795	Grey Felt Medium Density62	0KC5400	KLINGER®sil C-540035
0796	Grey Felt Firm62	0KC6400	KLINGER®sil C-640035
0797	White Felt Firm62	0KC7400	KLINGER®sil C-740036
0800	TFE60	0KC8200	KLINGER®sil C-820036
0801	25% Glass Filled TFE60	0KPSS	Thermoseal™ Milam Laminate PSS37
0825	Grafoil® GH™E61	OKSOFTCHEM	Thermoseal™ soft-chem™37
0826	Grafoil® GH™L61	OKTOPCHEM	KLINGER®top-chem-200038
0828	Grafoil® GH™R61	OKTOP2006	KLINGER®top-chem-200638
0832	316 S.S. Tang Flexible Graphite61	0M283V	Fluoroelastomer O-Ring Cord 75 Durometer (Metric)70
0833	Flexible Graphite61	0M284B	Buna-N O-Ring Cord 70 Durometer (Metric)70
0834	316 S.S. Foil Flexible Graphite61	0NOMEX	Nomex® Aramid Paper66
0880	Flange Protectors10	0N8051	Impervapac Nitrile Binder (Interface Solutions N-8051)46
0885P	Flange Protector Fastener Pins10	0N8090	Syntheseal Latent Cure Nitrile Binde (Interface Solutions N-8090)47
0885W	Flange Protector Fastener Washers11	0N8092	Syntheseal Fully Cured Nitrile Binder (Interface Solutions N-8092)47
0912	Fiberglass Tape64	0Q283	Fluoroelastomer Q- Ring Cord 75 Durometer .70	
0914	Drop Warp Fiberglass Tape64	0Q284	Buna-N Q-Ring Cord 70 Durometer70
0952	Mica Sheet66	0S8091	Syntheseal Latent Cure Styrene Butadiene Binder (Interface Solutions S-8091)47
0954	Daikin PCTFE Sheet66	0TN9001	Thermo-Tork Latent Cure Nitrile Butadiene Binder (Interface Solutions TN-9001)48
0CNA-750	CNA-750 Compressed Non-Asbestos Gasket Material28	0TS9013	Thermo-Tork Latent Cure Styrene Binder (Interface Solutions TS-9013)48
0D9000	Durlon® 9000 Filled PTFE60	0TS9016	Thermo-Tork Fully Cured Styrene Binder (Interface Solutions TS-9016)48
0G2900	Garlock Style 290042	1169	PTFE Filament Impregnated with PTFE19
0G3000	BLUE-GARD® 300042	1170	Lubricated PTFE Filament (Food Grade)19
0G3200	BLUE-GARD® 320043	1171	Braided Flexible Graphite Packing16
0G3300	BLUE-GARD® 330043	1173	TFE Impregnated Non-Asbestos Packing16
0G3500	GYLON® 350044	1174	TFE Filament19
0G3504	GYLON® 350444	1175	Graphite Filament Packing18
0G3510	GYLON® 351044	1176	Carbon Fiber with Graphite Coating18
0G3700	BLUE-GARD® 370043	1177	Novoloid Fiber/PTFE Impregnated Packing16
0KC4201	KLINGER®sil C-420129	1178	Aramid Filament Packing17
0KC4324	KLINGER®sil C-432430	1179	Carbon Filament/TFE Packing18
0KC4400	KLINGER®sil C-440030	1180	“G.F.O.®” Packing17
0KC4401	KLINGER®sil C-440131	1182	Braided Inconel Wire Inserted Carbon Yarn over Plastic Core17
0KC4408	KLINGER®sil C-440831			
0KC4409	KLINGER®sil C-440932			
0KC4430	KLINGER®sil C-443032			
0KC4433	KLINGER®sil C-443333			
0KC4439	KLINGER®sil C-443933			



Style Number Index

Style No.	Description	Page No.	Style No.	Description	Page No.
1189	Square Braided Non-Asbestos Graphited Packing	17	14AFIG	Parts for Allpax Extension Gasket Cutters	25
1189-1	Square Braided Non-Asbestos Graphited Packing	17	14C1203	Osborne Flexible Packing Hook Set	23
1196	Twisted Fiberglass Rope	21	14C1204	Osborne Flexible Packing Hooks (Individual)	23
1197	Twisted Fiberglass Wick	21	14C149	Individual Osborne Arch Punches	26
12C100S	100S Strip-N-Stick®	49	14C76½	Osborne Square Point Utility Knife	25
12C10TB	Temp-R-Glas® Fabric, Standard Grade	49	14C906P	Osborne Rigid Packing Tool Set	23
12C3320	COHR 3320 Fiberglass Reinforced Silicone Rubber	52	14CK14	Osborne Arch Punch Set	25
12C3TA	Temp-R-Glas® Fabric, Premium Grade	49	14CK156	Osborne Self-Centering Punch Kit	25
12C3TB	Temp-R-Glas® Fabric, Standard Grade	49	14CM50	Osborne Gasket and Washer Cutter	25
12C500	COHR Silicone Solid Rubber	51	14CM50B	Replacement Blades for Style 14CM50	25
12C5TA	Temp-R-Glas® Fabric, Premium Grade	49	14CMT10	Osborne Rigid Packing Screws	23
12C5TB	Temp-R-Glas® Fabric, Standard Grade	49	14CMT12	Osborne Rigid Double End Packing Tools	23
12C600	COHR Silicone Solid Rubber	51	14CMT32	Osborne Rigid Packing Hooks	24
12C6TB	Temp-R-Glas® Fabric, Standard Grade	49	14GA	Garco Packing Tool Set	24
12C700	COHR Silicone Solid Rubber	51	14GC	Garco Corkscrew Replacement Tips	24
12C9750	COHR 9750 Silicone Solid Red Rubber	52	14GF	Garco Flexible Shaft Packing Extractors	24
12CA2005	Temp-R-Glas® Tape	50	14M33OUS	Mayhew Hollow Punch Tool Kit	26
12CA2007	Temp-R-Glas® Tape	50	1545	Teflon® Cord Packing	19,22
12CA2008	Temp-R-Glas® Tape	50	1548	Sealex PTFE Cord Flange Sealant	22
12CA2012	Temp-R-Glas® Tape	50	2546	Import TFE Tape	22
12CC	Temp-R-Tape® C	50	2547	Domestic TFE Tape	22
12CHM	Temp-R-Tape® HM Series	50	734F	Tank Flange Gaskets	11
12CK	Kapton® Temp-R-Tape®	51	734F	Thief Hatch Gaskets	11
12CR10460	Silicone Sponge Rubber	52	734F	Hole Dome Gaskets	11
12CR10470	Silicone Sponge Rubber	52	782FC	Condenser Gaskets	11
12CR10480	Silicone Sponge Rubber	52	7GSW4	Spiral Wound Gaskets - 304 SS and Graphite	15
12CT	Temp-R-Tape® T	51	7GSW6	Spiral Wound Gaskets - 316L SS and Graphite	15
12CTH	Temp-R-Tape® TH	51	902	Non-Asbestos Metallic Oval Manhole Gaskets	12
12CTV350	Temp-R-Tape® TV350	51	903	Non-Asbestos Metallic Oval Handhole Gaskets	12
13734C	Chime or Lap Gaskets	11	906F	"O" Ring Bulb-Type Gaskets	12
13734TS375	Tank Strip 3/32" x 1 3/4" - Punched for 3/8" Bolts	11	907FC	Folded Non-Asbestos Tape	64
13734TS500	Tank Strip 3/32" x 1 3/4" - Punched for 1/2" Bolts	11	909F	Lead Core Packing	65
13735TS375	Tank Strip 3/32" x 1 3/4" - Punched for 3/8" Bolts	11	911F	Non-Asbestos Tadpole Tape with Non-Asbestos Rope	64
13735TS500	Tank Strip 3/32" x 1 3/4" - Punched for 1/2" Bolts	11	PSHIM	Co-Polyester Shim Stock	21
1460	Tallow Lubricated Flax Packing	20			
1463	PTFE Impregnated Flax	20			
14A	Allpax Extension Gasket Cutter	24			

Custom Fabrication



As described in the following pages of this catalog, APG provides a wide range of braided packing, non-asbestos gasket materials, tapes, extrusions, and tools. As "America's Most Responsive Warehouse" our goal is to always have it in stock and to ship it as soon as possible. In addition, we provide extensive custom fabrication capabilities to meet all your needs. From single gaskets to high volume production runs, we have the ability and flexibility to meet your needs.



In-house die-making to meet your exact specifications.



Our die library contains over 15,000 custom dies. All have customer part numbers ready to be retrieved on a moment's notice to process re-orders.



Automated equipment stands ready to assist us in fabricating your order.

Custom Fabrication



Our CAD/CAM system is utilized for fast, accurate die layouts or to program the water jet die cutting system.



We specialize in custom stripping, which can be supplied with adhesive backing on most materials.

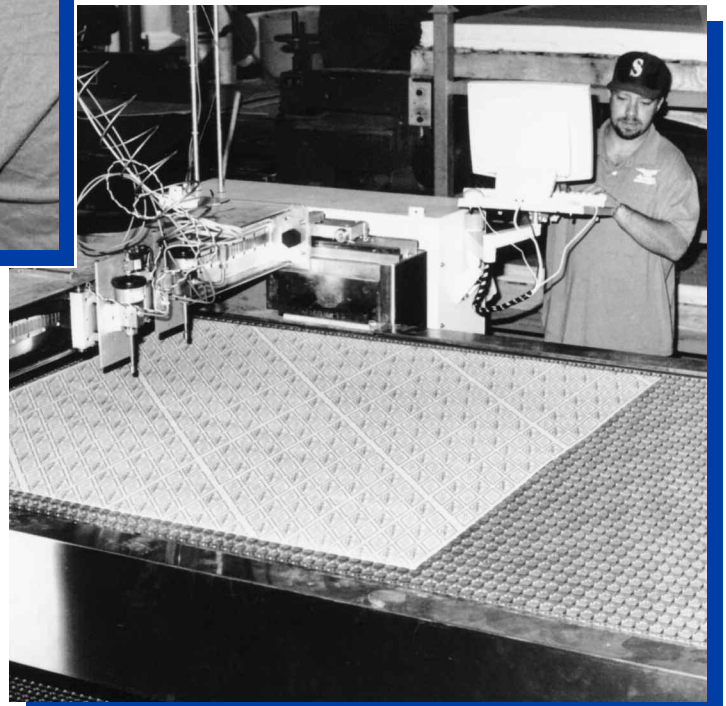

Our water jet cutting system provides extremely efficient fabrication capabilities.



Standard Fabricated Products



Pipe Flange Gasket Size Chart

APG can supply pipe flange gaskets in a broad range of materials. Just call us with your requirements.



Ring Gaskets 150 lb. Flanges			Full Face Gaskets 150 lb. Flanges			Ring Gaskets 300 lb. Flanges			Full Face Gaskets 300 lb. Flanges		
Nom. Pipe Size	ANSI Standard B 16.21		Nom. Pipe Size	ANSI Standard B 16.21		Nom. Pipe Size	ANSI Standard B 16.21		Nom. Pipe Size	ANSI Standard B. 16.21	
	I.D.	O.D.		I.D.	O.D.		I.D.	O.D.		I.D.	O.D.
1/2"	27/32"	1 7/8"	1/2"	27/32"	3 1/2"	1/2"	27/32"	2 1/8"	1/2"	27/32"	3 3/4"
3/4"	1 1/16"	2 1/4"	3/4"	1 1/16"	3 7/8"	3/4"	1 1/16"	2 5/8"	3/4"	1 1/16"	4 5/8"
1"	1 5/16"	2 5/8"	1"	1 5/16"	4 1/4"	1"	1 5/16"	2 7/8"	1"	1 5/16"	4 7/8"
1 1/4"	1 21/32"	3"	1 1/4"	1 21/32"	4 5/8"	1 1/4"	1 21/32"	3 1/4"	1 1/4"	1 21/32"	5 1/4"
1 1/2"	1 29/32"	3 3/8"	1 1/2"	1 29/32"	5"	1 1/2"	1 29/32"	3 3/4"	1 1/2"	1 29/32"	6 1/8"
2"	2 3/8"	4 1/8"	2"	2 3/8"	6"	2"	2 3/8"	4 3/8"	2"	2 3/8"	6 1/2"
2 1/2"	2 7/8"	4 7/8"	2 1/2"	2 7/8"	7"	2 1/2"	2 7/8"	5 1/8"	2 1/2"	2 7/8"	7 1/2"
3"	3 1/2"	5 3/8"	3"	3 1/2"	7 1/2"	3"	3 1/2"	5 7/8"	3"	3 1/2"	8 1/4"
3 1/2"	4"	6 3/8"	3 1/2"	4"	8 1/2"	3 1/2"	4"	6 1/2"	3 1/2"	4"	9"
4"	4 1/2"	6 7/8"	4"	4 1/2"	9"	4"	4 1/2"	7 1/8"	4"	4 1/2"	10"
4 1/2"	5"	7"	4 1/2"	5"	9 1/4"	4 1/2"	5"	7 5/8"	4 1/2"	5"	10 1/2"
5"	5 9/16"	7 3/4"	5"	5 9/16"	10"	5"	5 9/16"	8 1/2"	5"	5 9/16"	11"
6"	6 5/8"	8 3/4"	6"	6 5/8"	11"	6"	6 5/8"	9 7/8"	6"	6 5/8"	12 1/2"
7"	7 5/8"	10"	7"	7 5/8"	12 1/2"	7"	7 5/8"	10 7/8"	7"	7 5/8"	14"
8"	8 5/8"	11"	8"	8 5/8"	13 1/2"	8"	8 5/8"	12 1/8"	8"	8 5/8"	15"
9"	9 5/8"	12 1/2"	9"	9 5/8"	15"	9"	9 5/8"	12 1/8"	9"	9 5/8"	16 1/4"
10"	10 3/4"	13 3/8"	10"	10 3/4"	16"	10"	10 3/4"	14 1/4"	10"	10 3/4"	17 1/2"
12"	12 3/4"	16 1/8"	12"	12 3/4"	19"	12"	12 3/4"	16 5/8"	12"	12 3/4"	20 1/2"
14"	14"	17 3/4"	14"	14"	21"	14"	14"	19 1/8"	14"	14"	23"
16"	16"	20 1/4"	16"	16"	23 1/2"	16"	16"	21 1/4"	16"	16"	25 1/2"
18"	18"	21 5/8"	18"	18"	25"	18"	18"	23 1/2"	18"	18"	28"
20"	20"	23 7/8"	20"	20"	27 1/2"	20"	20"	25 3/4"	20"	20"	30 1/2"
22"	22"	26"	22"	22"	29 1/2"	22"	21"	27 5/8"	22"	22"	33"
24"	24"	28 1/4"	24"	24"	32"	24"	24"	30 1/2"	24"	24"	36"
26"	26"	30 1/2"	26"	26"	34 1/4"						
28"	28"	32 3/4"	28"	28"	36 1/2"						
30"	30"	34 3/4"	30"	30"	38 3/4"						
32"	32"	37"	32"	32"	41 3/4"						
34"	34"	39"	34"	34"	43 3/4"						
36"	36"	41 1/4"	36"	36"	46"						
38"	38"	43 3/8"	38"	38"	48 3/4"						
40"	40"	45 5/8"	40"	40"	50 3/4"						
42"	42"	48"	42"	42"	53"						
44"	44"	50 1/8"	44"	44"	55 1/4"						
46"	46"	52 1/8"	46"	46"	57 1/4"						
48"	48"	54 1/2"	48"	48"	59 1/2"						

(Continued on Next Page)



Pipe Flange Gasket Size Chart

(Continued from Previous Page)

Ring Gaskets 400 lb. Flanges			Ring Gaskets 600 lb. Flanges			Ring Gaskets 900 lb. Flanges			Ring Gaskets 1500 lb. Flanges		
Nom. Pipe Size	ANSI Standard B 16.21		Nom. Pipe Size	ANSI Standard B 16.21		Nom. Pipe Size	ANSI Standard B 16.21		Nom. Pipe Size	ANSI Standard B. 16.21	
	I.D.	O.D.		I.D.	O.D.		I.D.	O.D.		I.D.	O.D.
1/2"	27/32"	2 1/8"	1/2"	27/32"	2 1/8"	1/2"	27/32"	2 1/2"	1/2"	27/32"	2 1/2"
3/4"	1 1/16"	2 5/8"	3/4"	1 1/16"	2 5/8"	3/4"	1 1/16"	2 3/4"	3/4"	1 1/16"	2 3/4"
1"	1 5/16"	2 7/8"	1"	1 5/16"	2 7/8"	1"	1 5/16"	3 1/8"	1"	1 5/16"	3 1/8"
1 1/4"	1 21/32"	3 1/4"	1 1/4"	1 21/32"	3 1/4"	1 1/4"	1 21/32"	3 1/2"	1 1/4"	1 21/32"	3 1/2"
1 1/2"	1 29/32"	3 3/4"	1 1/2"	1 29/32"	3 3/4"	1 1/2"	1 29/32"	3 7/8"	1 1/2"	1 29/32"	3 7/8"
2"	2 3/8"	4 3/8"	2"	2 3/8"	4 3/8"	2"	2 3/8"	5 5/8"	2"	2 3/8"	5 5/8"
2 1/2"	2 7/8"	5 1/8"	2 1/2"	2 7/8"	5 1/8"	2 1/2"	2 7/8"	6 1/2"	2 1/2"	2 7/8"	6 1/2"
3"	3 1/2"	5 7/8"	3"	3 1/2"	5 7/8"	3"	3 1/2"	6 5/8"	3"	3 1/2"	6 7/8"
3 1/2"	4"	6 3/8"	3 1/2"	4"	6 3/8"	4"	4 1/2"	8 1/8"	4"	4 1/2"	8 1/4"
4"	4 1/2"	7"	4"	4 1/2"	7 5/8"	5"	5 9/16"	9 3/4"	5"	5 9/16"	10"
5"	5 9/16"	8 3/8"	5"	5 9/16"	9 1/2"	6"	6 5/8"	11 3/8"	6"	6 5/8"	11 1/8"
6"	6 5/8"	9 3/4"	6"	6 5/8"	10 1/2"	8"	8 5/8"	14 1/8"	8"	8 5/8"	13 7/8"
8"	8 5/8"	12"	8"	8 5/8"	12 5/8"	10"	10 3/4"	17 1/8"	10"	10 3/4"	17 1/8"
10"	10 3/4"	14 1/8"	10"	10 3/4"	15 3/4"	12"	12 3/4"	19 5/8"	12"	12 3/4"	20 1/2"
12"	12 3/4"	16 1/2"	12"	12 3/4"	18"	14"	14"	20 1/2"	14"	14"	22 3/4"
14"	14"	19"	14"	14"	19 3/8"	16"	16"	22 5/8"	16"	16"	25 1/4"
16"	16"	21 1/8"	16"	16"	22 1/4"						
18"	18"	23 3/8"	18"	18"	24 1/8"						
20"	20"	25 1/2"	20"	20"	26 7/8"						
24"	24"	30 1/4"	24"	24"	31 1/8"						

STYLE 0880

Flange Protectors

1/8" thick pressboard with 4 diametrically opposed 9/16" holes for securing with pins and washers (styles 0885P and 0885W listed below).



Nominal Pipe Size (inches)	For 150# Flanges		For 300# Flanges		For 600# Flanges	
	Part No.	Diameter (inches)	Part No.	Diameter (inches)	Part No.	Diameter (inches)
1/2"	0880A0050	3 1/2"	0880B0050	3 3/4"	0880B0050	3 3/4"
3/4"	0880A0075	3 7/8"	0880B0075	4 5/8"	0880B0075	4 5/8"
1"	0880A0100	4 1/4"	0880B0100	4 7/8"	0880B0100	4 7/8"
1 1/2"	0880A0150	5"	0880B0150	6 1/8"	0880B0150	6 1/8"
2"	0880A0200	6"	0880B0200	6 1/2"	0880B0200	6 1/2"
2 1/2"	0880A0250	7"	0880B0250	7 1/2"	0880B0250	7 1/2"
3"	0880A0300	7 1/2"	0880B0300	8 1/4"	0880B0300	8 1/4"
4"	0880A0400	9"	0880B0400	10"	0880C0400	10 3/4"
5"	0880A0500	10"	0880B0500	11"	0880C0500	13"
6"	0880A0600	11"	0880B0600	12 1/2"	0880C0600	14"
8"	0880A0800	13 1/2"	0880B0800	15"	0880C0800	16 1/2"
10"	0800A1000	16"	0880B1000	17 1/2"	0880C1000	20"
12"	0800A1200	19"	0800B1200	20 1/2"	0880C1200	22"
14"	0880A1400	21"	0880B1400	23"	0880C1400	23 3/4"
16"	0880A1600	23 1/2"	0880B1600	25 1/2"	0880C1600	27"
18"	0880A1800	25"	0880B1800	28"	0880C1800	28 1/4"
20"	0880A2000	27 1/2"	0880B2000	30 1/2"	0880C2000	32"
24"	0880A2400	32"	0880B2400	36"	0880C2400	37"
30"	0880A3000	38 3/4"	0880B3000	43"	0880C3000	44 1/2"

STYLE 0885P

Flange Protector Fastener Pins

Size	Part Number
#1 Pin - 2 1/4" long	0885P1
#2 Pin - 3 1/4" long	0885P2

Galvanized steel pins for fastening Style 0880 Flange Protectors.



STYLE 0885W Flange Protector Fastener Washers

Slotted plastic washers for fastening style 0880 Flange Protectors.

Size	Part Number
#1 Washer - 1 3/8" o.d.	0885W1
#2 Washer - 1 3/4" o.d.	0885W2

STYLE 782FC Condenser Gaskets

Fabricated from Style 782 (Plant Fibre Rubber - Beater Saturated).
Thickness: 1/16".

To Fit:
ZC-52 FM-118 FM-208
FM-346 FM-503 FM-739
Continental C46 Continental C66 and C96 Witte B
Witte C Witte 98 Lufkin H-333

Standard Fabricated Tank Gasketing

Standard Fabricated Tank Gasketing from Style 0734 Neoprene.



Description	Style/Part Number
Tank Strip 3/32" x 1 3/4" - Punched for 3/8" Bolts - Punched for 1/2" Bolts	13734TS375 13734TS500
Tank Flange Gaskets - 1" - 4" - 1 1/2" - 6" - 2" - 8" x 12 3/4" - 3"	734F
Dome Gaskets - 28 hole - 30 hole	734F
Thief Hatch Gaskets - 8" Round - 8" x 18" Oblong - 8" x 22" Oblong	734F
Chime or Lap Gaskets Chime or Lap Gasket - 2 1/2' Lengths	13734C 0734CX30
Radii Strip - 5' Lengths	0734R
Radii Gaskets - 1 3/4" - 2"	734F
Tank Bolt Washers	0734W

Standard Fabricated Tank Gasketing from Style 0735 Buna-N.

Description	Style/Part Number
Tank Strip 3/32" x 1 3/4" - Punched for 3/8" Bolts - Punched for 1/2" Bolts	13735TS375 13735TS500

**Save Time!
Fax us your orders or quote requests.**



STYLE 902

Non-Asbestos Metallic Oval Manhole Gaskets

Folded non-asbestos oval Manhole Gaskets. Woven fiberglass tacky cloth with brass wire inserted in both directions. Rated to 400°F. Standard Thickness: 1/4". Standard Flange Widths: 3/4", 1", and 1 1/4". *Call for other possible thicknesses, flange widths, and inside dimensions.*



Typical Inside Dimensions (inches)

9" x 14"
9" x 15"
10" x 14"
10" x 15"
10" x 16"
11" x 14"
11" x 15"
12" x 15"
12" x 16"
12" x 18"

STYLE 903

Non-asbestos Metallic Oval Handhole Gaskets

Folded non-asbestos Oval Handhole Gaskets. Woven fiberglass tacky cloth with brass wire inserted on both directions. Rated to 400°F. Standard Thickness: 1/4". Standard Flange Widths: 1/2", 5/8", and 3/4". *Call for other possible thicknesses, flange widths, and inside dimensions.*



Typical Inside Dimensions (inches)

2" x 3"
2 1/2" x 3 1/2"
2 1/2" x 4"
3" x 4"
3" x 4 1/2"
3 1/2" x 4 1/2"
3" x 5"
4" x 5"
4 1/2" x 5 1/2"
4" x 6"
5" x 6"
5" x 7"
6" x 7"
6" x 8"

STYLE 906F

"O" Ring Bulb-Type Gaskets

Folded non-asbestos "O" Ring Bulb-Type Gaskets, Woven fiberglass tacky cloth with brass wire inserted in both directions. "O" Ring compound comprising interior portion of bulb as specified by customer. Fiberglass cloth rated to 400°F. Temperature rating of "O" Ring compound varies with compound.

Description of Typical Gaskets

52 Hole National Fire Tube 64 Hole National Fire Tube 78 Hole National Fire Tube (3 pieces)
16" National Manway 52 Hole Sivalis Fire Tube 24 Hole Manway
30" BS&B Fire Tube Twenty 5/8" Bolt Holes on 19 7/8" BHC BS&B Manway Twenty 5/8" Bolt Holes on 22 1/2" BHC BS&B Manway
54 Hole Fire Tube 48 Hole Fire Tube 18" National Manway
24" National Manway 16" National Fire Tube 30" PESI
36" PESI 48" PESI 60" PESI

Questions?

Our knowledge is just a phone call away!



Spiral Wound Gaskets



Spiral wound gaskets are constructed with alternating components of formed metal wire and soft filler material. This forms a very effective seal when under proper flange compression. The metal strip has a V-shaped crown which gives the spiral wound gaskets increased resiliency under varying conditions. The wire materials and fillers can vary in order to meet the compatibility requirements of different chemical environments. Gasket construction and dimensions can be modified to provide an effective seal when available compression bonds are limited.

Spiral wound gaskets may have a centering ring and/or an inner ring. The outer centering ring aids in locating the gasket on the flange. The inner ring gives the gasket additional radial strength. It also helps to reduce flange erosion and protect the sealing element.

Spiral wound gaskets are widely used throughout refineries, chemical processing plants, power generation, aerospace, and other applications requiring a strong, resilient seal. New applications continue to be added with increasing environmental regulations and industry requirements.

Custom Gaskets - Spiral wound gaskets can be custom fabricated to meet a wide range of dimensional requirements. Call us with your specific application or specifications, and we will assist you in obtaining the spiral wound gasket to meet your needs.



“America’s Most Responsive Warehouse”

Let us show you why!



ASME B16.20 Spiral Wound Gasket Dimensions (ASME/ANSI B16.5 Flanges)

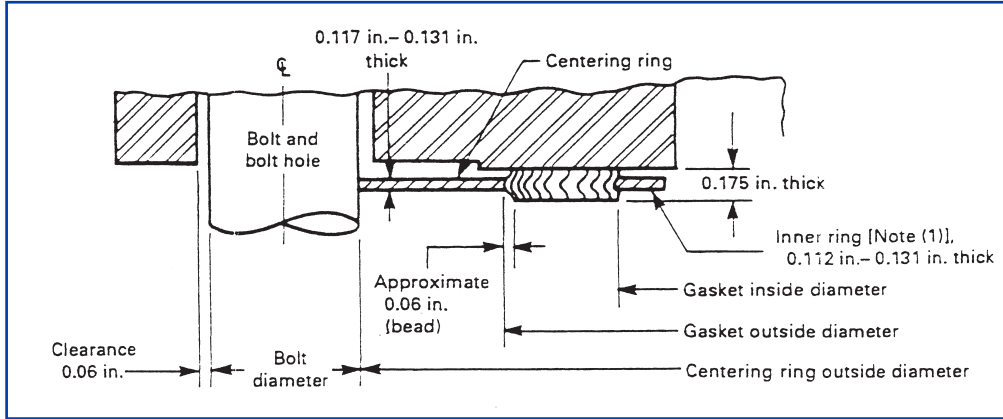

Flange Size (NPS)	Outside Diameter of Gasket		Inside Diameter of Gasket by Class								Outside Diameter of Centering Ring by Class					
	Classes 150, 300, 400, 600	Classes 900, 1500, 2500	150	300	400	600	900	1500	2500	150	300	400	600	900	1500	2500
1/2"	1.25	1.25	0.75	0.75	(2)	0.75	(2)	0.75	0.75	1.88	2.13	(2)	2.13	(2)	2.50	2.75
3/4"	1.56	1.56	1.00	1.00	(2)	1.00	(2)	1.00	1.00	2.25	2.63	(2)	2.63	(2)	2.75	3.00
1"	1.88	1.88	1.25	1.25	(2)	1.25	(2)	1.25	1.25	2.63	2.88	(2)	2.88	(2)	3.13	3.38
1-1/4"	2.38	2.38	1.88	1.88	(2)	1.88	(2)	1.56	1.56	3.00	3.25	(2)	3.25	(2)	3.50	4.13
1-1/2"	2.75	2.75	2.13	2.13	(2)	2.13	(2)	1.88	1.88	3.38	3.75	(2)	3.75	(2)	3.88	4.63
2"	3.38	3.38	2.75	2.75	(2)	2.75	(2)	2.31	2.31	4.13	4.38	(2)	4.38	(2)	5.63	5.75
2-1/2"	3.88	3.88	3.25	3.25	(2)	3.25	(2)	2.75	2.75	4.88	5.13	(2)	5.13	(2)	6.50	6.63
3"	4.75	4.75	4.00	4.00	(2)	4.00	3.75	3.63	3.63	5.38	5.88	(2)	5.88	6.63	6.88	7.75
4"	5.88	5.88	5.00	5.00	4.75	4.75	4.75	4.63	4.63(1)	6.88	7.13	7.00	7.63	8.13	8.25	9.25
5"	7.00	7.00	6.13	6.13	5.81	5.81	5.81	5.63	5.63(1)	7.75	8.50	8.38	9.50	9.75	10.00	11.00
6"	8.25	8.25	7.19	7.19	6.88	6.88	6.88	6.75	6.75(1)	8.75	9.88	9.75	10.50	11.38	11.13	12.50
8"	10.38	10.13	9.19	9.19	8.88	8.88	8.75	8.50	8.50(1)	11.00	12.13	12.00	12.63	14.13	13.88	15.25
10"	12.50	12.25	11.31	11.31	10.81	10.81	10.88	10.50	10.63(1)	13.38	14.25	14.13	15.75	17.13	17.13	18.75
12"	14.75	14.50	13.38	13.38	12.88	12.88	12.75	12.75(1)	12.50(1)	16.13	16.63	16.50	18.00	19.63	20.50	21.63
14"	16.00	15.75	14.63	14.63	14.25	14.25	14.00	14.25(1)	(2)	17.75	19.13	19.00	19.38	20.50	22.75	(2)
16"	18.25	18.00	16.63	16.63	16.25	16.25	16.25	16.00(1)	(2)	20.25	21.25	21.13	22.25	22.63	25.25	(2)
18"	20.75	20.50	18.69	18.69	18.50	18.50	18.25	18.25(1)	(2)	21.63	23.50	23.38	24.13	25.13	27.75	(2)
20"	22.75	22.50	20.69	20.69	20.50	20.50	20.50	20.25(1)	(2)	23.88	25.75	25.50	26.88	27.50	29.75	(2)
24"	27.00	26.75	24.75	24.75	24.75	24.75	24.75(1)	24.25(1)	(2)	28.25	30.50	30.25	31.13	33.00	35.50	(2)

Notes: (1) Inner ring required.
 (2) There are no Class 400 flanges in NPS 1/2 through NPS 3 (use Class 600), Class 900 flanges in NPS 1/2 through NPS 2-1/2 (use Class 1500), or Class 2500 flanges NPS 14 and larger.
 (3) Teflon® filled gaskets require an inner ring.

**STYLE 7GSW4****Spiral Wound Gaskets - 304 SS and Graphite
1/8" Carbon Steel Centering Ring**

Size (inches)	150# Part No.	300# Part No.	400# Part No.	600# Part No.	900# Part No.	1500# Part No.
1/4"	7GSW4A0025	7GSW4A0025	7GSW4A0025	7GSW4A0025		
1/2"	7GSW4A0050	7GSW4B0050	7GSW4B0050	7GSW4B0050	7GSW4E0050	7GSW4E0050
3/4"	7GSW4A0075	7GSW4B0075	7GSW4B0075	7GSW4B0075	7GSW4E0075	7GSW4E0075
1"	7GSW4A0100	7GSW4B0100	7GSW4B0100	7GSW4B0100	7GSW4E0100	7GSW4E0100
1 1/4"	7GSW4A0125	7GSW4B0125	7GSW4B0125	7GSW4B0125	7GSW4E0125	7GSW4E0125
1 1/2"	7GSW4A0150	7GSW4B0150	7GSW4B0150	7GSW4B0150	7GSW4E0150	7GSW4E0150
2"	7GSW4A0200	7GSW4B0200	7GSW4B0200	7GSW4B0200	7GSW4E0200	7GSW4E0200
2 1/2"	7GSW4A0250	7GSW4B0250	7GSW4B0250	7GSW4B0250	7GSW4E0250	7GSW4E0250
3"	7GSW4A0300	7GSW4B0300	7GSW4B0300	7GSW4B0300	7GSW4E0300	7GSW4F0300
4"	7GSW4A0400	7GSW4B0400	7GSW4C0400	7GSW4D0400	7GSW4E0400	7GSW4F0400
5"	7GSW4A0500	7GSW4B0500	7GSW4C0500	7GSW4D0500	7GSW4E0500	7GSW4F0500
6"	7GSW4A0600	7GSW4B0600	7GSW4C0600	7GSW4D0600	7GSW4E0600	7GSW4F0600
8"	7GSW4A0800	7GSW4B0800	7GSW4C0800	7GSW4D0800	7GSW4E0800	7GSW4F0800
10"	7GSW4A1000	7GSW4B1000	7GSW4C1000	7GSW4D1000	7GSW4E1000	7GSW4F1000
12"	7GSW4A1200	7GSW4B1200	7GSW4C1200	7GSW4D1200	7GSW4E1200	7GSW4F1200
14"	7GSW4A1400	7GSW4B1400	7GSW4C1400	7GSW4D1400	7GSW4E1400	7GSW4F1400
16"	7GSW4A1600	7GSW4B1600	7GSW4C1600	7GSW4D1600	7GSW4E1600	7GSW4F1600
18"	7GSW4A1800	7GSW4B1800	7GSW4C1800	7GSW4D1800	7GSW4E1800	7GSW4F1800
20"	7GSW4A2000	7GSW4B2000	7GSW4C2000	7GSW4D2000	7GSW4E2000	7GSW4F2000
24"	7GSW4A2400	7GSW4B2400	7GSW4C2400	7GSW4D2400	7GSW4E2400	7GSW4F2400

Note: Part numbers in shaded areas are not normally stock items. Special order.

STYLE 7GSW6**Spiral Wound Gaskets - 316L SS and Graphite
1/8" Carbon Steel Centering Ring**

Size (inches)	150# Part No.	300# Part No.	400# Part No.	600# Part No.	900# Part No.	1500# Part No.
1/4"	7GSW6A0025	7GSW6A0025	7GSW6A0025	7GSW6A0025		
1/2"	7GSW6A0050	7GSW6B0050	7GSW6B0050	7GSW6B0050	7GSW6E0050	7GSW6E0050
3/4"	7GSW6A0075	7GSW6B0075	7GSW6B0075	7GSW6B0075	7GSW6E0075	7GSW6E0075
1"	7GSW6A0100	7GSW6B0100	7GSW6B0100	7GSW6B0100	7GSW6E0100	7GSW6E0100
1 1/4"	7GSW6A0125	7GSW6B0125	7GSW6B0125	7GSW6B0125	7GSW6E0125	7GSW6E0125
1 1/2"	7GSW6A0150	7GSW6B0150	7GSW6B0150	7GSW6B0150	7GSW6E0150	7GSW6E0150
2"	7GSW6A0200	7GSW6B0200	7GSW6B0200	7GSW6B0200	7GSW6E0200	7GSW6E0200
2 1/2"	7GSW6A0250	7GSW6B0250	7GSW6B0250	7GSW6B0250	7GSW6E0250	7GSW6E0250
3"	7GSW6A0300	7GSW6B0300	7GSW6B0300	7GSW6B0300	7GSW6E0300	7GSW6F0300
4"	7GSW6A0400	7GSW6B0400	7GSW6C0400	7GSW6D0400	7GSW6E0400	7GSW6F0400
5"	7GSW6A0500	7GSW6B0500	7GSW6C0500	7GSW6D0500	7GSW6E0500	7GSW6F0500
6"	7GSW6A0600	7GSW6B0600	7GSW6C0600	7GSW6D0600	7GSW6E0600	7GSW6F0600
8"	7GSW6A0800	7GSW6B0800	7GSW6C0800	7GSW6D0800	7GSW6E0800	7GSW6F0800
10"	7GSW6A1000	7GSW6B1000	7GSW6C1000	7GSW6D1000	7GSW6E1000	7GSW6F1000
12"	7GSW6A1200	7GSW6B1200	7GSW6C1200	7GSW6D1200	7GSW6E1200	7GSW6F1200
14"	7GSW6A1400	7GSW6B1400	7GSW6C1400	7GSW6D1400	7GSW6E1400	7GSW6F1400
16"	7GSW6A1600	7GSW6B1600	7GSW6C1600	7GSW6D1600	7GSW6E1600	7GSW6F1600
18"	7GSW6A1800	7GSW6B1800	7GSW6C1800	7GSW6D1800	7GSW6E1800	7GSW6F1800
20"	7GSW6A2000	7GSW6B2000	7GSW6C2000	7GSW6D2000	7GSW6E2000	7GSW6F2000
24"	7GSW6A2400	7GSW6B2400	7GSW6C2400	7GSW6D2400	7GSW6E2400	7GSW6F2400

Note: Part numbers in shaded areas are not normally stock items. Special order.



Braided Packing and Related Products



General Service Packings

STYLE 1171

Braided Flexible Graphite Packing

Interbraid construction. Pure homogenous graphite bonded to a fiberglass carrier for strength and thermal stability. Forms a dense yet pliable braided packing. Recommended for use in condensate pumps, boiler water feed pumps, and valves. Also recommended for rotating shafts with high shaft speeds where thermal conductivity is required. Shaft speeds to 4000 FPM. Temperatures to 850° F/455° C in oxidizing atmospheres; 1250° F/675° C in steam. Pressure to 5000 PSI steam service; ph range 0-14. Packaged in 10 lb. boxes which may be broken for smaller orders.

Size	Approx. Ft/Lb.	Part Number
1/8"	100	11710125
3/16"	50	11710187
1/4"	33.1	11710250
5/16"	20	11710312
3/8"	14.2	11710375
7/16"	11.1	11710437
1/2"	8.4	11710500
9/16"	6	11710562
5/8"	4.7	11710625
3/4"	3.1	11710750
1"	2.1	11711000

STYLE 1173

TFE Impregnated Non-asbestos Packing

Interbraid construction. Yarns dipped in TFE suspensoid. Fibers are saturated and sealed with TFE particles, protecting the fibers from chemical action. TFE provides a greater degree of chemical inertness, lower coefficient of friction and prevents penetration of chemical fluids. A surface coating of TFE is applied after braiding for extra protection. To assure good break-in characteristics, a light oil is applied. Recommended for general service, rotating and reciprocating pumps and agitators. For caustics, mild acids, difficult chemicals, air, gases, solvents, oils and general plant application. For pH 3-11; PV factor 650,000; temperatures to 500°F/260°C; speeds to 1885 FPM. The proprietary TFE dispersion system provides greater penetration and more thorough dissemination of the inert TFE. Packaged in 10 lb. boxes, which may be broken for smaller orders.

Size	Approx. Ft/Lb.	Part Number
1/8"	84.0	11730125
3/16"	48.5	11730187
1/4"	22.2	11730250
5/16"	17.2	11730312
3/8"	11.7	11730375
7/16"	8.4	11730437
1/2"	6.6	11730500
9/16"	5.4	11730562
5/8"	4.3	11730625
3/4"	3.1	11730750
7/8"	2.3	11730875
1"	1.8	11731000

STYLE 1177

Novoloid Fiber/PTFE Impregnated Packing

Interbraid construction. Braided Novoloid fiber with PTFE impregnation, lubricated with a unique lubrication process that transforms each individual fiber into a reservoir of lubrication for longer packing life. An excellent high performance alternative. Proprietary non-petroleum lubricant containing no sulphur, silicone or wax. Recommended for rotating and reciprocating pumps, washer journals, liquor pumps, refiners, digesters and many other uses. For general service applications where graphite may not be acceptable: steam, water, acid, chemical and solvent applications, multi-use in chemical plants and pulp and paper mills. For shaft speeds up to 1800 FPM; temperatures up to 500°F/260°C; pH range 1-13 (except concentrated or hot sulfuric or nitric acid). Packaged in 10 lb. boxes which may be broken for smaller orders.

Size	Approx. Ft/Lb.	Part Number
1/8"	100	11770125
3/16"	50	11770187
1/4"	20	11770250
5/16"	14.3	11770312
3/8"	11.1	11770375
7/16"	9.1	11770437
1/2"	6.3	11770500
9/16"	5.6	11770562
5/8"	4	11770625
3/4"	2.9	11770750
7/8"	2.2	11770875
*1"	1.8	11771000

* Not an APG stock item. Special order.



STYLE 1178 Aramid Filament Packing

Interbraid construction. A non-asbestos Aramid fiber; a synthetic fiber displaying many of the characteristics of asbestos. Each strand is individually treated with a TFE coating and a light, inert oil. Recommended for rotating and reciprocating shafts and all equipment on which braided asbestos packings are used. For general service, caustics, mild acids, chemicals, air, oil, gases, solvents and general chemical plant applications. For speeds up to 1900 FMP; temperatures to 500°F/260°C; pH Range 3-11 (same as TFE impregnated asbestos). Packaged in 10 lb. boxes which may be broken for smaller orders.

Size	Approx. Ft/Lb.	Part Number
1/8"	78	11780125
3/16"	37	11780187
1/4"	24	11780250
5/16"	15.5	11780312
3/8"	11.1	11780375
7/16"	8.0	11780437
1/2"	6.5	11780500
5/8"	4.2	11780625
3/4"	3	11780750
*1"	1.8	11781000

* Not an APG stock item. Special order.

STYLE 1180 "G.F.O."® Packing (Registered Trademark of W.L. Gore Co.)

Interbraid construction. Finely ground particles of the highest quality graphite in a TFE matrix to control graphite migration. Lubricated with a proprietary high speed lubricant. Recommended for all reciprocating and rotating shafts. For all corrosive applications suitable for TFE & graphite. For shaft speeds to 4400 FPM; temperatures to 550°F/187°C, pH range 0-14. Packaged in 10 lb. boxes which may be broken for smaller orders.

Size	Approx. Ft/Lb.	Part Number
1/8"	73	11800125
3/16"	33	11800187
1/4"	19.4	11800250
5/16"	13.1	11800312
3/8"	9	11800375
7/16"	7.6	11800437
1/2"	5.8	11800500
9/16"	4.6	11800562
5/8"	3.7	11800625
3/4"	2.6	11800750
7/8"	1.9	11800875
1"	1.5	11801000

STYLE 1182 Braided Inconel Wire-inserted Carbon Yarn over Plastic Core

Braided Inconel wire-inserted carbon yarn over a high temperature resistant homogenous plastic core with special high temperature binder and graphite. A corrosive inhibitor is added to protect the valve. Molycoated surface treatment. Recommended for steam, superheated steam, air, petroleum products and hot gases. For valve service; maximum line temperature 1200°F/649°C, pressures to 2500 p.s.i. Packaged in 10 lb. boxes which may be broken for smaller orders.

Size	Approx. Ft/Lb.	Part Number
1/8"	103	11820125
3/16"	38	11820187
1/4"	24	11820250
5/16"	16.5	11820312
3/8"	11.5	11820375
*1/2"	7	11820500

* Not an APG stock item. Special order.

STYLE 1189 Square Braided Non-asbestos Graphited Packing

Square braided construction. Non-asbestos fibers treated with a specially formulated blend of lubricants having a saxoline base. Each strand is individually coated with graphite and the braid is surface coated with graphite. Recommended for general service on rotary and reciprocating equipment. For mild acids, alkalines, steam, brine, oil. Speeds to 1885 FPM; temperatures to 450°F/232°C; pH range 4-10. A good general service packing. The lubrication formulation makes the extra difference. The ductile nature of the lubricant prevents wicking and provides superior sealability. Packaged in 10 lb. boxes which cannot be broken. (See Style 1189-1 packed in 1 lb. boxes.)

Size	Approx. Ft/Lb.	Part Number
3/8"	14	11890375
7/16"	10.5	11890437
1/2"	8	11890500
9/16"	6.5	11890562
5/8"	5	11890625
3/4"	3.6	11890750
7/8"	3	11890875
1"	2	11891000

STYLE 1189-1 Square Braided Non-asbestos Graphited Packing

Same as Style 1189 except packaged in 1 lb. boxes.

Size	Approx. Ft/Lb.	Part Number
1/8"	105	1189-10125
3/16"	47	1189-10187
1/4"	31	1189-10250
5/16"	18.9	1189-10312
3/8"	14	1189-10375
7/16"	10.5	1189-10437
1/2"	8	1189-10500



Graphite Yarn Packings

STYLE 1175

Graphite Filament Packing

Interbraid construction. Manufactured from pure graphite yarns impregnated with a fine submicron powder of inorganic graphite. A surface lubricant is applied to prevent wicking and to provide a bearing film between the shaft and the packing material. Recommended for valves, high speed shafts, agitator shafts, reciprocating rods and plunger rods wherever minimum product leakage is required under severe service conditions. For strong acids and strong caustics throughout the full pH range. It is virtually inert. Not recommended for oleum, fuming nitric acid and fluorine. Temperatures up to 6,000°F/3,316°C in non-oxidizing agents, 1200°F/649°C in steam, and 800°F/427°C in oxidizers. Use wherever downtime costs are too great to permit the use of mechanical seal replacement. Installed and maintained properly, this packing can run on little or no leakage. Packaged in 1 lb. boxes which cannot be broken.

Size	Approx. Ft/Lb.	Part Number
1/8"	140	11750125
3/16"	69	11750187
1/4"	44.3	11750250
5/16"	27	11750312
*3/8"	19.1	11750375
*1/2"	14	11750500

* Not an APG stock item. Special order.

Carbon Yarn Packings

STYLE 1176

Carbon Fiber with Graphite Coating

Interbraid construction. A unique combination of amorphous carbon yarns treated throughout with fine particles of graphite. Recommended for general service rotating and reciprocating shafts, high temperature valves. For all chemical services in which carbon is suitable. For shaft speeds up to 3,000 FPM; temperatures to 650°F/345°C in oxidizing atmospheres; 1200°F/650°C in steam; pH range 0-14 except in strong oxidizers. An excellent alternative in applications where asbestos packings are not permitted and graphite yarn packings are too expensive. Does not have quite the low coefficient of friction and the heat conductivity of pure graphite filaments, but carbon yarns treated with graphite exhibit better heat conductivity and frictional characteristics than either asbestos or TFE. Packaged in 10 lb. boxes which may be broken for smaller orders.

Size	Approx. Ft/Lb.	Part Number
1/8"	126	11760125
3/16"	58	11760187
1/4"	35.2	11760250
5/16"	27	11760312
3/8"	17.5	11760375
1/2"	10.2	11760500
5/8"	6.6	11760625
*3/4"	4.8	11760750
*7/8"	3.6	11760875
*1"	2.8	11761000

* Not an APG stock item. Special order.

STYLE 1179

Carbon Filament/TFE Packing

Interbraid construction. A carbon filament packing treated with TFE to prevent color contamination and carbon migration. Each individual strand of the carbon yarn is treated and impregnated with a TFE suspensoid, totally encapsulating the packing to prevent carbon filaments from migrating into the pumpage. Recommended for pulp mill equipment, steaming vessels, top separators, refiners, outlet devices, blow pumps, stock pumps, agitators and valves. For most chemical services, except strong oxidizers. Shaft speeds to 2,400 FPM; temperatures to 600°F/345°C; pH range 0-14. Packaged in 10 lb. boxes which may be broken for smaller orders.

Size	Approx. Ft/Lb.	Part Number
1/8"	93	11790125
3/16"	43	11790187
1/4"	22.1	11790250
5/16"	14.9	11790312
3/8"	10.9	11790375
1/2"	6.2	11790500
5/8"	3.9	11790625
3/4"	2.9	11790750
*1"	1.7	11791000

* Not an APG stock item. Special order.

TFE Packings

STYLE 1169 PTFE Filament Impregnated with PTFE

Interbraid construction. Pre-lubricated yarns to provide a softer, more flexible packing with improved peripheral speed characteristics and exothermic properties. Recommended for any equipment where braided packings are commonly used. Dynamic and static applications. For the most severe services. All oxidizers and corrosives with one exception: molten alkali metals. PV factor 650,000; pH range 0-14; speeds up to 1200 FPM. No glazing at higher speed applications, inert, virtually indestructible, lower coefficient of friction, thermal resistance to 500°F/260°C; and high compressive strength. Packaged in 10 lb. boxes which may be broken for smaller orders.

Size	Approx. Ft/Lb.	Part Number
*1/8"	72	11690125
*3/16"	31.5	11690187
1/4"	19.4	11690250
5/16"	12.5	11690312
3/8"	9	11690375
1/2"	5.1	11690500
5/8"	3.3	11690625
3/4"	2.4	11690750
7/8"	1.7	11690875
1"	1.2	11691000

* Not an APG stock item. Special order.

STYLE 1170 Lubricated PTFE Filament (Food Grade)

Interbraid construction. Pure TFE filament lubricated with a proprietary lubricant that satisfies all FDA requirements. Recommended for any equipment where braided packings are commonly used. For all applications in the food processing industry or anywhere FDA material is required. For temperatures to 500°F/260°C; pH 0-14; shaft speeds to 1200 FPM. Packaged in 10 lb. boxes which may be broken for smaller orders.

Size	Approx. Ft/Lb.	Part Number
*1/8"	72	11700125
*3/16"	31.5	11700187
1/4"	19.4	11700250
5/16"	12.5	11700312
3/8"	9	11700375
1/2"	5.1	11700500
5/8"	3.3	11700625
3/4"	2.3	11700750
7/8"	1.7	11700875
*1"	1.2	11701000

* Not an APG stock item. Special order.

STYLE 1174 TFE Filament

Interbraid construction. TFE fibers are treated with a TFE dispersion which fills and seals all interstices in the packing fibers. After braiding, a TFE coating is applied and the packing is forced air dried. This packing will not wick. Recommended for valves, expansion joints, and static applications. For all severe chemical and corrosive services where an inert packing material is essential. For temperatures to 500°F/260°C; PV factor 650,000; pH range 0-14. Excellent valve stem packing for all chemicals and corrosives; inert to all fluids except molten alkali metals. Packaged in 10 lb. boxes which may be broken for smaller orders.

Size	Approx. Ft/Lb.	Part Number
1/8"	74	11740125
3/16"	32	11740187
1/4"	20.6	11740250
5/16"	13.5	11740312
3/8"	9.5	11740375
7/16"	7	11740437
1/2"	5.5	11740500
5/8"	3.3	11740625
3/4"	2.5	11740750
1"	1.6	11741000

STYLE 1545 Teflon® Cord Packing

100% pure PTFE round packing and gasket material. Self lubricating and non-hardening. A tough fibrous PTFE core and low friction surface is more chemically inert than conventional string packings and has greater resistance to cold flow under pressure. Recommended for flanges, valve or faucet stems, pump housings, stuffing boxes, rotary pump shafts, reciprocating rods, centrifugal pumps, rams and expansion joints. For most acids, alkalies, solvents, fuels, air, water, steam, refrigerants, gases and liquified gases. Temperature from -450°F to 500°F. Not recommended for oxygen service. Packaged on plastic spools with shell. Twelve rolls per plain white display box.



Size	Part Number
3/32" x 20'	1545093x20
3/32" x 50'	1545093x50
5/32" x 15'	1545156x15
5/32" x 35'	1545156x35



Vegetable Fiber Packings

STYLE 1460 Tallow Lubricated Flax Packing

Square braided construction. Flax fibers lubricated with a pure edible tallow and wax compound. Recommended for reciprocating and rotary shafts, plungers, hydraulic rams and stern tubes. For brine, cold water and cold oil. High speed shafts. High pressure rams and accumulators. Temperatures to 220°F/104°C, pH 5-9, shaft speeds to 1885 FPM.

Packaging: 1/8" - 3/16" 10 lb. boxes
 1/4" - 1 1/8" 10 to 13 lb. boxes
 1 1/4" - 1 1/2" 25 lb. spools.
 1 3/4" - 2" 50 lb. spools.

(Boxes cannot be broken.)

Size	Approx. Ft/Lb.	Part Number
1/8"	87	14600125
3/16"	45	14600187
1/4"	28	14600250
5/16"	18.6	14600312
3/8"	13.3	14600375
7/16"	10.5	14600437
1/2"	7.7	14600500
9/16"	6.1	14600562
5/8"	4.9	14600625
3/4"	3.5	14600750
7/8"	2.6	14600875
1"	1.9	14601000
1 1/8"	1.28	14601125
1 1/4"	1.10	14601250
1 3/8"	1	14601375
1 1/2"	.75	14601500
1 3/4"	.5	14601750
2"	.28	14602000

STYLE 1463 PTFE Impregnated Flax

Square braid construction. Highest quality long line flax fibers impregnated with TFE dispersion and a special break-in oil. Recommended for reciprocating and rotating shafts, stern tube packing. Paper mill applications are Jordans, clafins, hydrofiners and stock pumps. Recommended for brine, cold water and cold oil. For speeds to 1885 FPM; temperatures to 220°F/104°C; PV factor 175,000; pH range 5-9. TFE impregnant acts as: (1) a surface leveler filling any surface voids (2) a saturant to prevent wicking (3) a lubricant to reduce friction and heat and (4) a protective shield around the flax fibers, preventing fluid penetration and fiber break down. An excellent paper stock packing. Use wherever product discoloration must be prevented, such as in the food and bleached paper industries. Packaged in 10 lb. boxes which may be broken for smaller orders.

Size	Approx. Ft/Lb.	Part Number
1/4"	22	14630250
5/16"	15.5	14630312
3/8"	10.5	14630375
1/2"	6	14630500
5/8"	4.4	14630625
3/4"	3.1	14630750
7/8"	2.3	14630875
1"	1.8	14631000

In addition to the products in this catalog, APG supplies o-rings, industrial hose couplings, industrial glass, and much, much more! See pages 71 and 72.



Fiberglass Rope and Wick

STYLE 1196 Twisted Fiberglass Rope

Highly flexible fiberglass fabric tightly twisted and formed into a rope of various diameters. Non-flammable, will not burn or smolder. Excellent electrical properties. Recommended for furnace doors, ovens, manhole covers, etc. For air, dry steam, hot gases. Temperatures to 1000°F/538°C. Packaged on 25 lb. spools which must be sold as unbroken spools.

Size	Approx. Ft/Lb.	Part Number
3/8"	24.5	11960375
1/2"	13.5	11960500
5/8"	9.0	11960625
3/4"	6.5	11960750
1"	3.7	11961000

STYLE 1197 Twisted Fiberglass Wick

Same as our style 1196 fiberglass rope except loosely twisted and formed into a 1/4" diameter. Packaged on 25 lb. spools which must be sold as unbroken spools.

Size	Approx. Ft/Lb.	Part Number
1/4"	54	11970250

Shim Stock

STYLE PSHIM Co-Polyester Shim Stock

Co-polyester (Plastic) shim material. Translucent to clear in color. For use where plastic shims are permitted. Materials can be thickness coded if needed. Tensile Strength @ Yield (T.D. 8300psi D 882). Rockwell Hardness, R Scale 112, D 785.

Size	Part Number
.001" x 40"	PSHIM001X40
.002" x 40"	PSHIM002x40
.003" x 40"	PSHIM003X40
.004" x 48"	PSHIM004X48
.005" x 48"	PSHIM005X48
.007" x 48"	PSHIM007X48
.010" x 48"	PSHIM010X48
.015" x 43"	PSHIM015X43
.020" x 43"	PSHIM020x43

Questions?
Our knowledge is just a phone call away!



TFE Thread Sealant Tape

STYLE 2547
STYLE 2546

Domestic TFE Tape
Import TFE Tape

TFE Thread Sealant Tape is TFE resin in ribbon form. It is the easiest, fastest, most simple method to seal any threaded joint. Joints are easily disconnected because TFE retains its lubricity while providing corrosion-proof sealing in applications up to 30,000 p.s.i. It will not deteriorate with age. Because TFE is inert to most solvents, Thread Sealant Tape can be used without fear of contamination. Temperature range: -450°F to 500°F. Applications include cooling, heating, refrigeration, cryogenic, steam line, petrochemical, aircraft and aerospace.



Domestic Part Number	Size	Import Part Number
2547A	1/2" x 260"	2546A
2547B	1/2" x 520"	2546B
2547C	1/2" x 1296"	2546C
2547D	3/4" x 260"	2546D
2547E	3/4" x 520"	2546E
2547F	3/4" x 1296"	2546F
2547G	1" x 260"	2546G
2547H	1" x 520"	2546H
2547I	1" x 1296"	2546I

Both the domestic and import tapes meet MIL Spec. T-27730A. Packaged in individual plastic spools with snap-on cover.

PTFE Flange Sealants

STYLE 1548

Sealex PTFE Cord Flange Sealant

Sealex is an extruded flexible PTFE cord which combines malleability and ruggedness, enabling it to be used in difficult sealing applications. Its high compressibility requires only light flange bolt pressure to seal effectively (essential for plastic, glass, or ceramic). Applications include pressure vessels, saturated steam, ductwork, heat exchangers, chemical/corrosive environments, and unconventional gasket requirements. Operates to 500°F/2000 p.s.i. Packaged on spools, adhesive-backed. FDA compliant.



Size	Part Number
1/8" x 100'	15480125
3/16" x 75'	15480187
1/4" x 50'	15480250
3/8" x 25'	15480375
3/8" x 250'	15480375X250
1/2" x 15'	15480500
1/2" x 150'	15480500X150
5/8" x 15'	15480625
5/8" x 150'	15480625X150
3/4" x 20'	15480750
3/4" x 100'	15480750X100
1" x 80'	15481000X80

STYLE 1545

Teflon® Cord Packing

See description on page 19.

Remember:

Same or next day shipment on stock items.



Packing and Gasket Tools

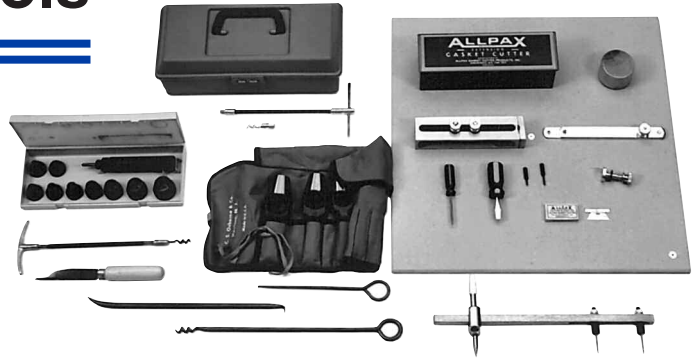

STYLE 14C1203 Osborne Flexible Packing Hook Set

Set includes packing hooks with a flexible strong shaft made with two spiral steel coils, one inside the other, wound in opposite directions for those inaccessible areas. Handle is solid zinc. Hook is tempered and permanently pointed. Boxed set includes #1, #2, and #3 hooks (see dimensions in Style 14C1204 below).



STYLE 14C1204 Osborne Flexible Packing Hooks (Individual)

Same as described above in Style 14C1203 except each size sold individually. Size #4 sold individually only.

Part Number	Size	Overall Length	Diameter of Shaft	Diameter of Spiral	Length of Spiral
14C1204-1	#1	6 1/4"	3/16"	1/4"	3/4"
14C1204-2	#2	10 5/8"	1/4"	5/16"	1 1/8"
14C1204-3	#3	15"	3/8"	3/8"	1 1/2"
14C1204-4	#4	18"	3/8"	1/2"	1 7/8"

STYLE 14C906P Osborne Rigid Packing Tool Set

Set includes rigid packing tools constructed of special tool steel and guaranteed against breaking in service. Specifically designed for removing packing from stuffing boxes. Oil finish. Set of six includes: 6", 10", 14", 18" packing screw; 8" packing hook; and 12" double end.

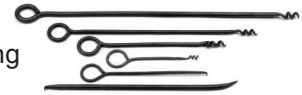

STYLE 14CMT10 Osborne Rigid Packing Screws

Packing screws as described above in Style 14C906P.



Length	Part Number
6"	14CMT10-6
8"	14CMT10-8
10"	14CMT10-10
14"	14CMT10-14
18"	14CMT10-18

STYLE 14CMT12 Osborne Rigid Double End Packing Tools

Double End Tools as described above in Style 14C906P.



Length	Part Number
6"	14CMT12-6
8"	14CMT12-8
12"	14CMT12-12



STYLE 14CMT32 Osborne Rigid Packing Hooks

Packing hooks as described on page 23 in Style 14C906P.



Length	Part Number
6"	14CMT32-6
8"	14CMT32-8
10"	14CMT32-10
12"	14CMT32-12

STYLE 14GA Garco Packing Tool Set

Set includes packing tools with both rigid and flexible shafts. The flexible shaft tools have replaceable tips which can be replaced at minimum cost when worn or damaged. Plated for corrosion protection. Meet or exceed government specifications. Set includes two (2) 14GR-1 flexible shaft tools; two (2) 14GF-2 flexible shaft tools; three (3) 14GC-1 corkscrew tips; three (3) 14GC-2 corkscrew tips; three (3) solid 10" picks for 1/8" and up, 3/16" and up, and 5/16" and up packing; plus wrench for removing tips. Packaged in a rustproof toolbox. (See Style 14GF below for description of flexible shaft tools.)



STYLE 14GF Garco Flexible Shaft Packing Extractors

These tools feature replaceable tips which can be replaced at minimum cost when worn or damaged. Plated for corrosion protection. Meet or exceed government specifications. Includes corkscrew tip. (See Style 14GC below for replacement tips.)



Part Number	Length	Thread	Packing	Tip Included
14GF-1	7 1/2"	8-32	5/16" & up	14GC-1
14GF-2	11"	1/4 - 20	7/16" & up	14GC-2
14GF-3	14 1/2"	1/4 - 20	1/2" & up	14GC-3

STYLE 14GC Garco Corkscrew Replacement Tip

Replacement corkscrew tip for Style 14GF.



Part Number	Packing	Fits Shaft
14GC-1	5/16" & up	14GF-1
14GC-2	7/16" & up	14GF-2&3
14GC-3	1/2" & up	14GF-2&3

Note: Other Garco packing tools and accessories are available from APG by special order.

STYLE 14A Allpax Extension Gasket Cutter

Cuts accurate gaskets quickly and efficiently. Cuts all gasketing materials, including compressed non-asbestos, cork, rubber, Teflon®, fibre, etc. in thicknesses up to 3/4". Sets include 18" x 18" cutting boards and fibre cutting pads. Six (6) regular cutting blades. Packed in metal boxes.



Part Number	Capacity
14A #2	1/4" - 24"
14A #3	1/4" - 36"



STYLE 14AFIG **Parts for Allpax Extension Gasket Cutters**

Additional and replacement parts for Style 14A on page 24.

Description	Part Number
Regular Cutting Blades (Package of 6)	14AFIG3
Heavy Duty Cutting Blades (Package of 6)	14AFIG3A
Short Center Pin - 1/2" Shank	14AFIG8
Long Center Pin - 3/4" Shank	14AFIG8A
Cutting Board Complete - 18" x 18"	14AFIG12
Cutting Board Complete - 24" x 24"	14AFIG12A
Fibre Cutting Pad - 18" x 18"	14AFIG14
Fibre Cutting Pad - 24" x 24"	14AFIG14A

STYLE 14CM50 **Osborne Gasket and Washer Cutter**

Designed for cutting circular gaskets and washers any size up to and including 24" outside diameter. Can be used with bit brace or by hand. Weight: 1 1/4 lbs.



STYLE 14CM50B **Replacement Blades for Style 14CM50**

Replacement blades for Osborne Gasket and Washer Cutter described above.

STYLE 14CK156 **Osborne Self-Centering Punch Kit**

This handy and versatile kit contains threaded handle with self-centering pointed plunger. This handle will accommodate nine inter-changeable threaded cutting tubes. The punches in this set will cleanly cut leather, rubber, paper, plastics and other soft materials. The self-centering point makes these punches ideal for cutting concentric washers in small quantities by hand. Hardened cutting edges. Includes tube sizes: 1/4", 5/16", 3/8", 7/16", 1/2", 5/8", 3/4", 7/8", and 1". Weight: 2 1/4 lbs. Packaged in a plastic box.



STYLE 14CK14 **Osborne Arch Punch Set**

Set includes seven (7) arch punches (1/4", 3/8", 1/2", 5/8", 3/4", 7/8", and 1") in a canvas tool roll. Osborne arch punches are drop forged in one piece from carbon steel. Inside taper permits the punchings to clear easily through the barrel. Polished barrel and black enamel handle. Cutting edge is fully tempered all the way through. Wooden or rawhide mallet recommended. Steel hammers not recommended. Meets government standards. Weight: 4 lbs.



STYLE 14C76 1/2 **Osborne Square Point Utility Knife**

Steel blade with round wooden handle, brass ferrule. Especially suited to cut all types of sheet gasket materials and braided packings.



Length of Blade	Width of Blade	Weight	Part Number
3 7/8"	5/8"	2 oz.	14C76 1/2



STYLE 14C149 Individual Osborne Arch Punches

Individual punches as described in Style 14C14 on page 25. Larger sign and millimeter sizes available on special order. Sizes larger than 2 1/4" made with properly engineered two piece welded construction. Millimeter sizes in green enamel.

Diameter (inches)	Approx. Weight (lbs)	(oz)	Part Number
3/16"	-	3	14C1490187
1/4"	-	3	14C1490250
5/16"	-	3	14C1490312
3/8"	-	5	14C1490375
7/16"	-	6	14C1490437
1/2"	-	7	14C1490500
9/16"	-	8	14C1490562
5/8"	-	9	14C1490625
11/16"	-	8	14C1490687
3/4"	-	12	14C1490750
13/16"	-	12	14C1490812
7/8"	-	12	14C1490875
15/16"	1	-	14C1490937
1"	1	-	14C1491000
1 1/16"	1	-	14C1491062
1 1/8"	1	2	14C1491125
1 3/16"	1	-	14C1491187
1 1/4"	1	6	14C1491250
1 5/16"	1	6	14C1491312
1 3/8"	1	6	14C1491375
1 7/16"	2	-	14C1491437
1 1/2"	2	-	14C1491500
1 9/16"	1	11	14C1491562
1 5/8"	1	12	14C1491625
1 11/16"	1	10	14C1491687
1 3/4"	3	-	14C1491750
1 13/16"	3	-	14C1491812
1 7/8"	3	8	14C1491875
1 15/16"	3	8	14C1491937
2"	3	8	14C1492000

STYLE 14M330US Mayhew 16 piece Hollow Punch Tool Kit

Features the only dual cutting heads in the marketplace. May be paired and interchanged for an endless combination of size possibilities. Unique patented design of locking system allows the cutting tools to be changed and locked in place for precise cuts. Used for cutting out washers and sealing rings from a multitude of materials. Punch sizes included: 1/8", 3/16", 1/4", 5/16", 3/8", 7/16", 1/2", 9/16", 5/8", 3/4", 7/8", 1", 1-1/16", 1-1/8", and 1-3/16".

Case dimensions: 8-3/4" x 6-1/4" x 1-1/2".

Weight: 2.47 lbs

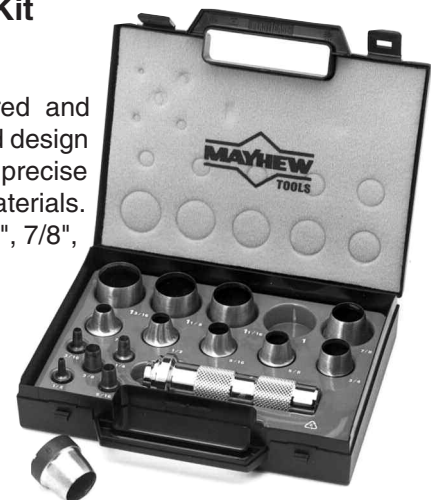



“America’s Most Responsive Warehouse”

Some of the Reasons Why



Prompt, friendly response to every call from every valued customer.

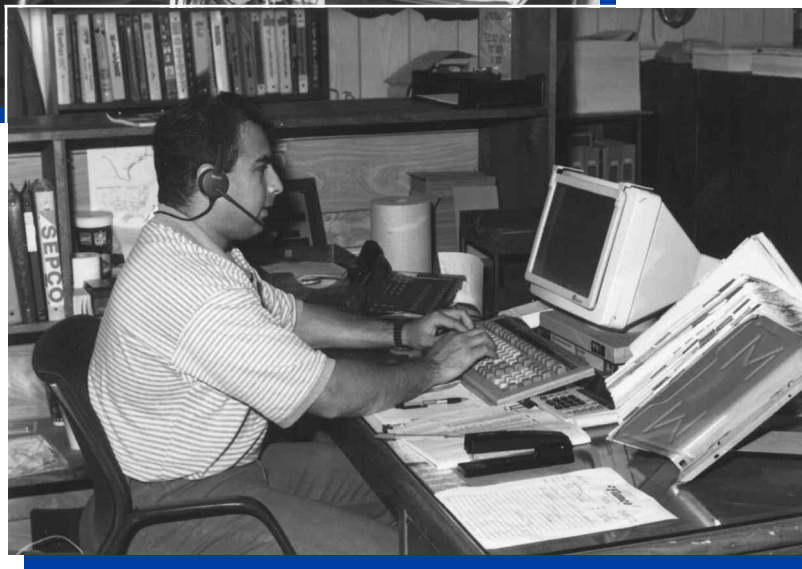

Experienced sales staff to get you what you want, when you need it.



Sheet Materials and Tapes



Non-Asbestos Gasket Materials

STYLE 0CNA-750

CNA-750 Compressed Non-Asbestos Gasket Material

Nitrile bound non-asbestos gasket material. Displays good torque retention and excellent creep resistance. Good resistance to oil, solvents, and many other media. Tensile strength 1670 psi typical (ASTM F152 Cross Grain). Change in tensile strength 25% maximum decrease (ASTM F152).

Size	Part Number
1/64" X 60" X 180"	0CNA750015X60X180
1/32" X 60" X 180"	0CNA750031X60X180
1/16" X 60" X 180"	0CNA750062X60X180
1/8" X 60" X 180"	0CNA750125X60X180

Note: Longest lengths stocked by APG are indicated. Shorter lengths always available.

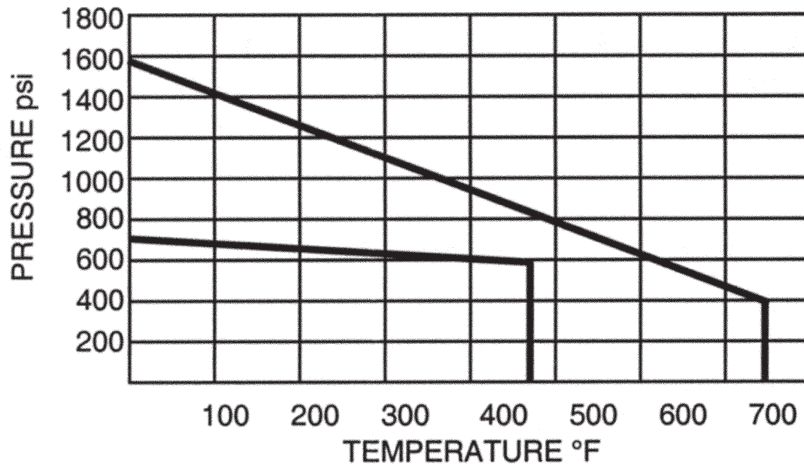

SERVICE LIMITS

Temperature Limits

Maximum 750°F
Continuous Maximum 460°F

PRESSURE LIMITS

Maximum 1595 psi
Continuous Maximum 725 psi

The P x T graph shown at above indicates the service limits for this sheet considering pressure and temperature simultaneously...(Tests were performed with nitrogen on 1.6 mm thick sheet). The "normal" curve represents the common usage area for this sheet while the "maximum" curve indicates the maximum limits. For application near or above the "maximum" curve, contact APG.



Non-Asbestos Gasket Materials

STYLE 0KC4201 KLINGER®sil C-4201

Synthetic fiber; nitrile binder; excellent resistance to oil and solvents; good anti-stick properties, excellent OEM material. Tensile strength 1500 PSI typical (ASTM F152 Cross Grain). Change in tensile strength 25% maximum decrease (ASTM 152). ASTM F104 Line Call Out - F712121B3E21M5.

Size	Part Number
*1/32" x 60" x 180"	0KC4201062x60x180
*3/64" x 60" x 180"	
1/16" x 60" x 180"	
*3/32" x 60" x 180"	0KC4201125x60x180
1/8" x 60" x 180"	
*3/16" x 60" x 60"	
*1/4" x 60" x 60"	

* Not an APG stock item. Special order.

Note: Longest lengths stocked by APG are indicated. Shorter lengths always available. Longer length of 3/16" and 1/4" available by special order.

C-4201
Pressure and
Temperature
Graphs

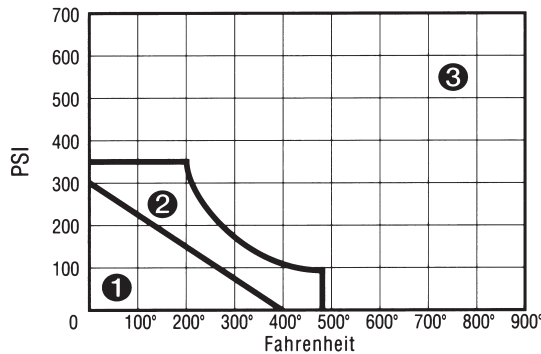

Liquids

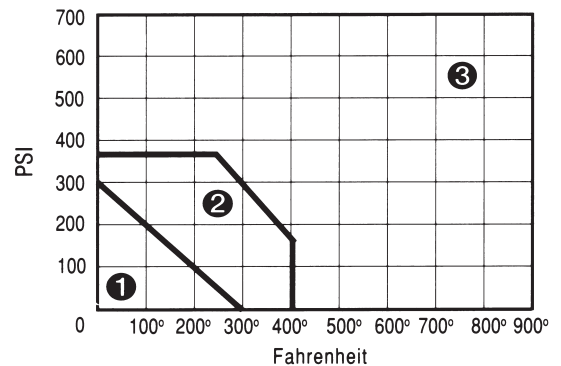

Gases and Steam

- ① In area one, the gasket material is suitable using common installation practices subject to chemical compatibility.
- ② In area two, appropriate measures are necessary for installation of the gasket to insure maximum performance. Please call APG or Thermoseal Technical Support Service for assistance.
- ③ In area three, DO NOT INSTALL GASKETS in these applications without first contacting APG or Thermoseal Technical Support Service.

Note: Manufacturers' brochures are available from APG if more technical information is required. Please inquire.

**For chemical resistance of KLINGER®sil products,
see chart on pages 39–41.**



STYLE 0KC4324 KLINGER®sil C-4324

Size	Part Number
1/32" x 60" x 180"	0KC4324031x60x180
1/16" x 60" x 180"	0KC4324062x60x180
1/8" x 60" x 180"	0KC4324125x60x180

Note: Longest lengths stocked by APG are indicated. Shorter lengths always available.

Recycled fiberglass and aramid blend; nitrile binder; low pressure steam, water and gases; good for oils and fuels. Tensile strength 1500 PSI typical (ASTM F152 Cross Grain). Change in tensile strength 30% maximum decrease (ASTM F152). ASTM F104 Line Call Out F71212B3E12M5.

C-4324
Pressure and
Temperature
Graphs

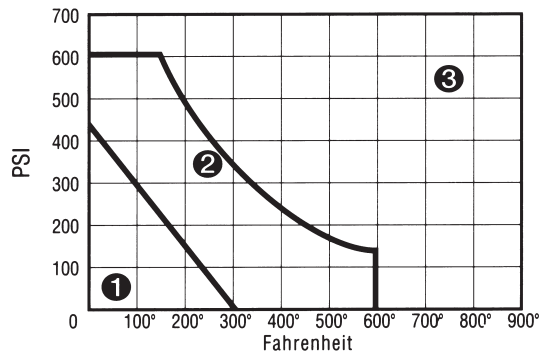

Liquids

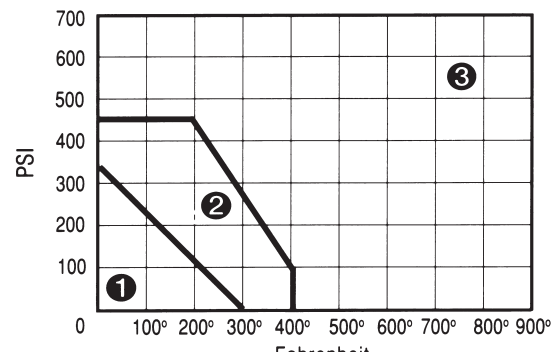

Gases and Steam

STYLE 0KC4400 KLINGER®sil C-4400

Characteristics are similar to KLINGER®sil C-4401 which represents a next generation of C-4400. APG does stock limited quantities of C-4400. Special orders also available. Please inquire.

- ① In area one, the gasket material is suitable using common installation practices subject to chemical compatibility.
- ② In area two, appropriate measures are necessary for installation of the gasket to insure maximum performance. Please call APG or Thermoseal Technical Support Service for assistance.
- ③ In area three, DO NOT INSTALL GASKETS in these applications without first contacting APG or Thermoseal Technical Support Service.

Note: Manufacturers' brochures are available from APG if more technical information is required. Please inquire.

**For chemical resistance of KLINGER®sil products,
see chart on pages 39–41.**



STYLE 0KC4401 KLINGER®sil C-4401

Synthetic fiber; nitrile binder; excellent sealability; excellent chemical resistance; good creep relaxation; good general purpose sheet. Tensile strength 1500 PSI typical (ASTM F152 Cross Grain). Change in tensile strength 25% maximum decrease (ASTM F152). ASTM F104 Line Call Out - F712121B3E21M6.

Size	Part Number
1/64" x 60" x 180"	0KC4401015x60x180
1/32" x 60" x 180"	0KC4401031x60x180
*3/64" x 60" x 180"	
1/16" x 60" x 180"	0KC4401062x60x180
3/32" x 60" x 180"	0KC4401093x60x180
1/8" x 60" x 180"	0KC4401125x60x180
3/16" x 60" x 60"	0KC4401187x60x60
1/4" x 60" x 60"	0KC4401250x60x60

* Not an APG stock item. Special order.

Note: Longest lengths stocked by APG are indicated. Shorter lengths always available. Longer length of 3/16" and 1/4" available by special order.

C-4401
Pressure and
Temperature
Graphs

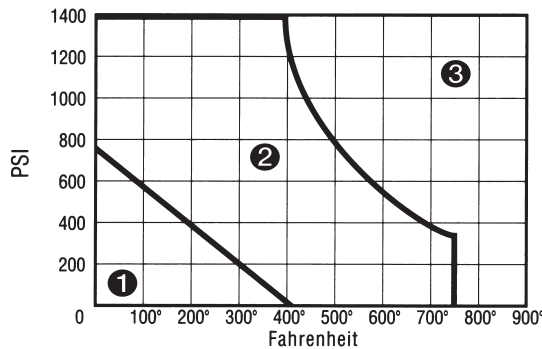

Liquids

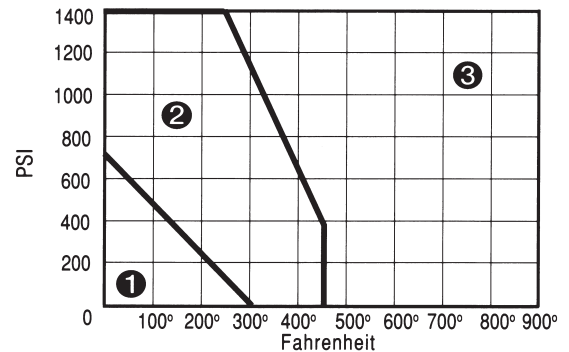

Gases and Steam

STYLE 0KC4408 KLINGER®sil C-4408

Synthetic fiber; nitrile binder; high temperature and stress; fluctuating temperatures and pressures; vibration; wire reinforced with a low carbon steel woven mesh insert. Tensile strength 3000/5000 PSI typical (ASTM F152 Cross Grain/With Grain). Change in tensile strength 15% (ASTM 152). ASTM F104 Line Call Out - F712122B2E21M6.

Size	Part Number
*1/32" x 60" x 180"	
*3/64" x 60" x 180"	
1/16" x 60" x 180"	0KC4408062x60x180
*3/32" x 60" x 180"	
1/8" x 60" x 180"	0KC4408125x60x180

* Not an APG stock item. Special order.

Note: Longest lengths stocked by APG are indicated. Shorter lengths always available.

C-4408
Pressure and
Temperature
Graphs

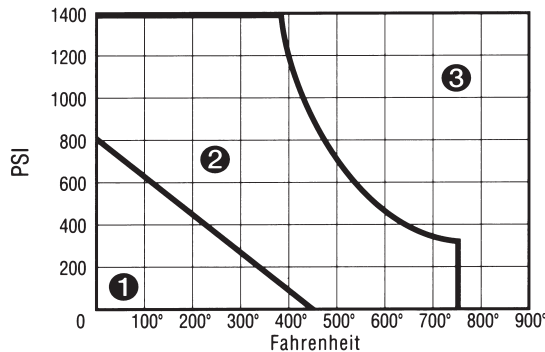

Liquids

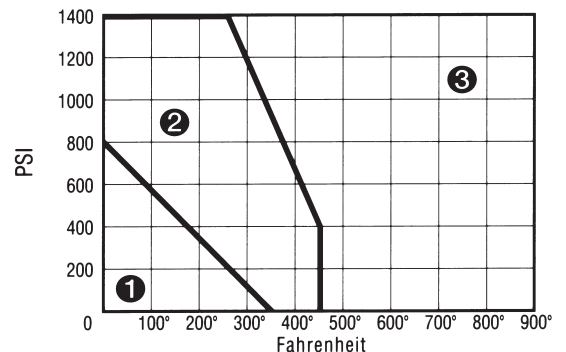

Gases and Steam

- ① In area one, the gasket material is suitable using common installation practices subject to chemical compatibility.
- ② In area two, appropriate measures are necessary for installation of the gasket to insure maximum performance. Please call APG or Thermoseal Technical Support Service for assistance.
- ③ In area three, DO NOT INSTALL GASKETS in these applications without first contacting APG or Thermoseal Technical Support Service.

Note: Manufacturers' brochures are available from APG if more technical information is required. Please inquire.



STYLE 0KC4409 KLINGER®sil C-4409

**Not an APG stock item.
Special Order**

Synthetic fiber; nitrile binder; high temperature and stress; excellent hot gases; replaces spiral wounds; vibration; reinforced with a galvanized low carbon expanded steel insert. Tensile strength 6000/4000 PSI typical (ASTM F152 CrossGrain/With Grain). Change in tensile strength 12% (ASTM F152). ASTM F104 Line Call Out - F712111B2E11M8.

C-4409
Pressure and
Temperature
Graphs

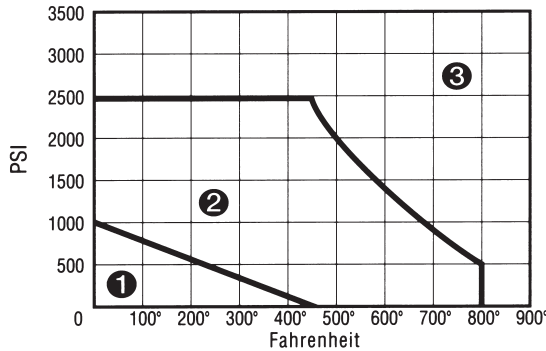

Liquids

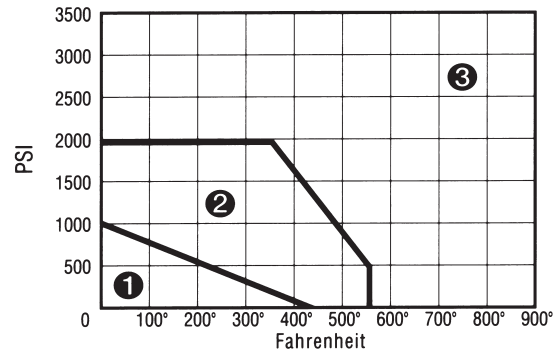

Gases and Steam

STYLE 0KC4430 KLINGER®sil C-4430

Size	Part Number
1/64" x 60" x 180"	0KC4430015x60x180
1/32" x 60" x 180"	0KC4430031x60x180
1/16" x 60" x 180"	0KC4430062x60x180
*3/32" x 60" x 180"	0KC4430125x60x180
1/8" x 60" x 180"	

Fiberglass and aramid fibers; nitrile binder; ultimate steam sheet; excellent chemical resistance; outstanding creep relaxation; best general purpose sheet. Tensile strength 1800 typical (ASTM F152 Cross Grain). Change in tensile strength 25% maximum decrease (ASTM F152). ASTM F104 Line Call Out - F712132B2E21M5.

* Not an APG stock item. Special order.
Note: Longest lengths stocked by APG are indicated. Shorter lengths always available.

C-4430
Pressure and
Temperature
Graphs

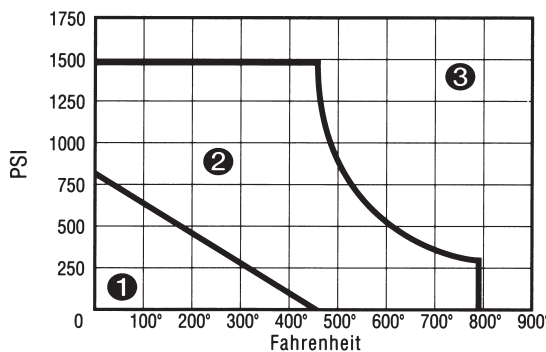

Liquids

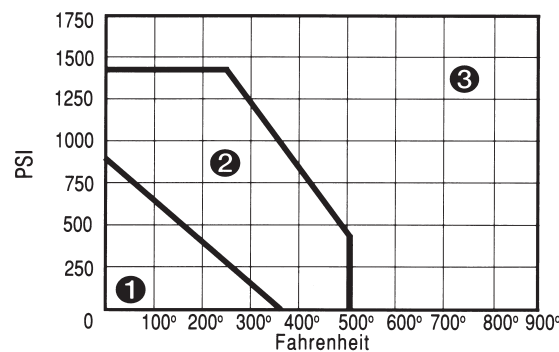

Gases and Steam

- ① In area one, the gasket material is suitable using common installation practices subject to chemical compatibility.
- ② In area two, appropriate measures are necessary for installation of the gasket to insure maximum performance. Please call APG or Thermoseal Technical Support Service for assistance.
- ③ In area three, DO NOT INSTALL GASKETS in these applications without first contacting APG or Thermoseal Technical Support Service.

Note: Manufacturers' brochures are available from APG if more technical information is required. Please inquire.



STYLE 0KC4433 KLINGER®sil C-4433

Fiberglass, aramid and inorganic fibers; nitrile binder; ultimate steam sheet; outstanding load bearing; excellent creep relaxation. Tensile strength 1500 psi typical (ASTM F152 Cross Grain). Change in tensile strength 25% maximum decrease (ASTM F152). ASTM F104 Line Call Out F712132B3E21M5.

Size	Part Number
1/32" X 60" X 180"	OKC4433031X60X180
1/16" X 60" X 180"	OKC4433062X60X180
1/8" X 60" X 180"	OKC4433125X60X180

Note: Longest lengths stocked by APG are indicated. Shorter lengths always available.

C-4433
Pressure and
Temperature
Graphs

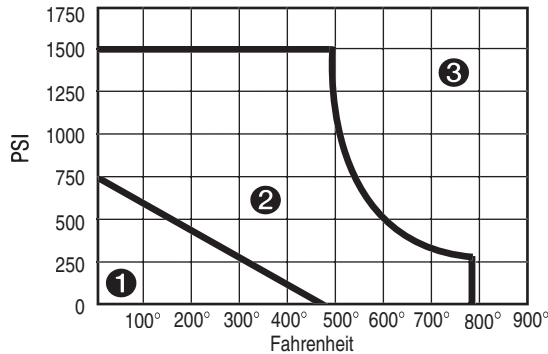

Liquids

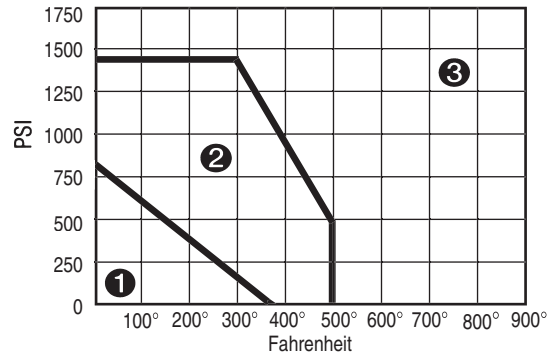

Gases and Steam

STYLE 0KC4439 KLINGER®sil C-4439

Fiberglass and aramid fibers; nitrile binder; high temperature and stress; vibration; reinforced with a galvanized low carbon expanded steel insert. Tensile strength 6000/4000 PSI typical (ASTM F152 Cross Grain/With Grain). Change in tensile strength 20% (ASTM F152). ASTM F104 Line Call Out - F712121B3E12M8Z1.

Size	Part Number
*.040" X 60" X 180"	
1/16" X 60" X 180"	OKC4439062X60X180
*.080" X 60" X 180"	
1/8" X 60" X 80"	OKC4439125X60X180

* Not an APG stock item. Special order.
Note: Longest lengths stocked by APG are indicated. Shorter length always available.

C-4439
Pressure and
Temperature
Graphs

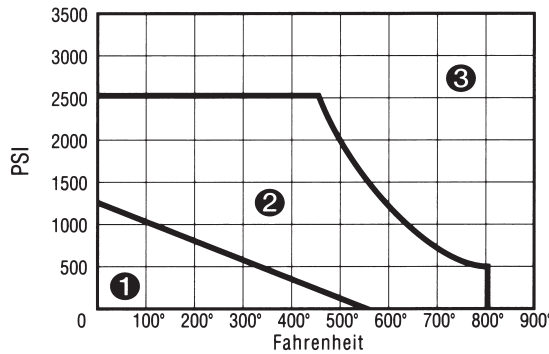

Liquids

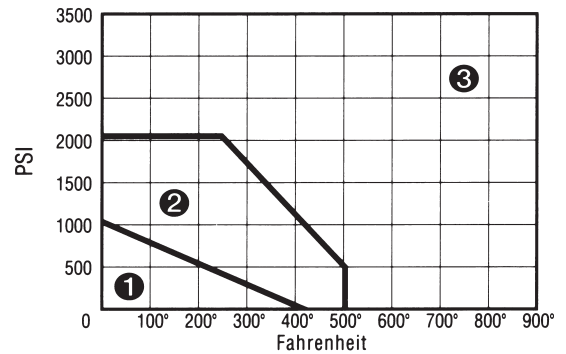

Gases and Steam

- 1 In area one, the gasket material is suitable using common installation practices subject to chemical compatibility.
- 2 In area two, appropriate measures are necessary for installation of the gasket to insure maximum performance. Please call APG or Thermoseal Technical Support Service for assistance.
- 3 In area three, DO NOT INSTALL GASKETS in these applications without first contacting APG or Thermoseal Technical Support Service.

Note: Manufacturers' brochures are available from APG if more technical information is required. Please inquire.



STYLE 0KC4500 KLINGER®sil C-4500

Size	Part Number
1/64" x 60" x 60"	0KC4500015x60x60
1/32" x 60" x 180"	0KC4500031x60x180
1/16" x 60" x 180"	0KC4500062x60x180
*3/32" x 60" x 180"	
1/8" x 60" x 180"	0KC4500125x60x180

Carbon fiber; nitrile binder; high temperature; high internal pressure; excellent steam sheet; suitable for a wide range of chemical applications. Tensile strength 1500 PSI typical (ASTM F152 Cross Grain). Change in tensile strength 25% maximum decrease (ASTM F15 2). ASTM F104 Line Call Out F712122B3E22M5.

* Not an APG stock item. Special order.

Note: Longest lengths stocked by APG are indicated. Shorter lengths always available. Longer lengths of 1/64" available by special order.

C-4500 Pressure and Temperature Graphs

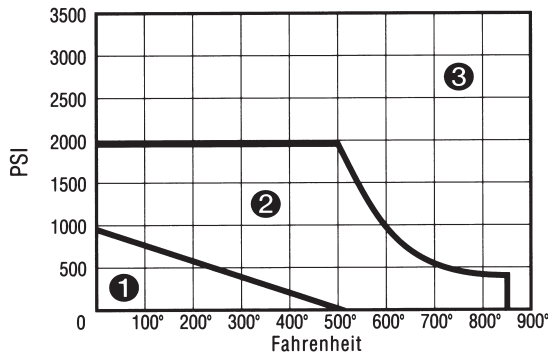

Liquids

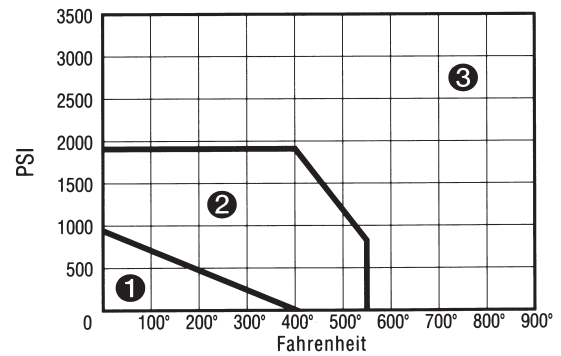

Gases and Steam

STYLE 0KC4509 KLINGER®sil C-4509

Not an APG stock item. Special Order

Carbon fiber; nitrile binder; good in high load applications; vibration; reinforced with a galvanized low carbon expanded steel insert. Tensile strength 6000/4000 PSI typical (ASTM F152 Cross Grain/With Grain). Change in tensile strength 15% (ASTM F152). ASTM F104 Line Call Out F712122B3E22M8Z1.

C-4509 Pressure and Temperature Graphs

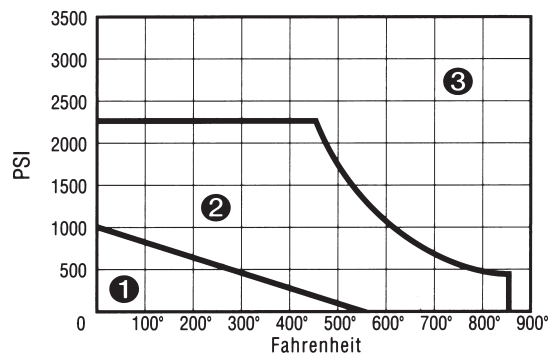

Liquids

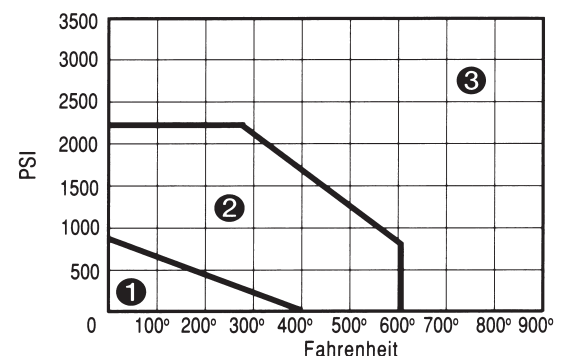

Gases and Steam

- ① In area one, the gasket material is suitable using common installation practices subject to chemical compatibility.
- ② In area two, appropriate measures are necessary for installation of the gasket to insure maximum performance. Please call APG or Thermoseal Technical Support Service for assistance.
- ③ In area three, DO NOT INSTALL GASKETS in these applications without first contacting APG or Thermoseal Technical Support Service.

Note: Manufacturers' brochures are available from APG if more technical information is required. Please inquire.



STYLE 0KC5400 KLINGER®sil C-5400

Synthetic fiber; neoprene binder; chemically stable; good anti-stick properties. Tensile strength 1600 PSI typical (ASTM F152 Cross Grain). Change in tensile strength 50% maximum decrease. ASTM F104 Line Call Out F712332B5E45M5.

Size	Part Number
1/64" x 60" x 180"	0KC5400015x60x180
1/32" x 60" x 180"	0KC5400031x60x180
*3/64" x 60" x 180"	
1/16" x 60" x 180"	0KC5400062x60x180
*3/32" x 60" x 180"	
1/8" x 60" x 180"	0KC5400125x60x180
*3/16" x 60" x 60"	
*1/4" x 60" x 60"	

* Not an APG stock item. Special order.
Note: Longest lengths stocked by APG are indicated. Shorter lengths always available. Longer length of 3/16" and 1/4" available by special order.

C-5400
Pressure and
Temperature
Graphs

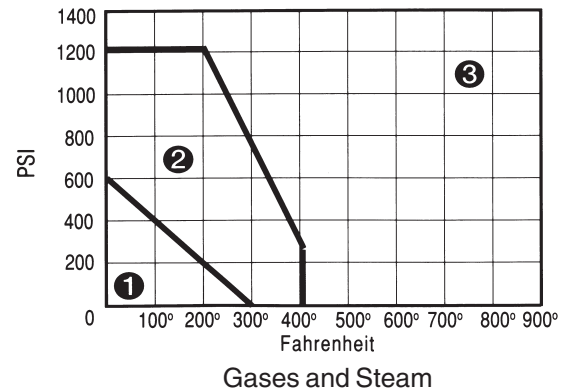
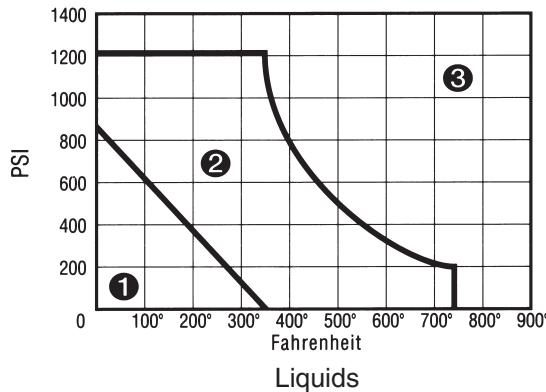

STYLE 0KC6400 KLINGER®sil C-6400

Synthetic fiber; SBR binder; good anti-stick properties; good steam sheet. Tensile strength 1600 PSI typical (ASTM F152 Cross Grain). Change in tensile strength 50% maximum decrease (ASTM F152). ASTM F104 Line Call Out F712541B3E45M5.

Size	Part Number
1/64" x 60" x 180"	0KC6400015x60x180
1/32" x 60" x 180"	0KC6400031x60x180
*3/64" x 60" x 180"	
1/16" x 60" x 180"	0KC6400062x60x180
*3/32" x 60" x 180"	
1/8" x 60" x 180"	0KC6400125x60x180
*3/16" x 60" x 60"	
*1/4" x 60" x 60"	

* Not an APG stock item. Special order.
Note: Longest lengths stocked by APG are indicated. Shorter lengths always available. Longer length of 3/16" and 1/4" available by special order.

C-6400
Pressure and
Temperature
Graphs

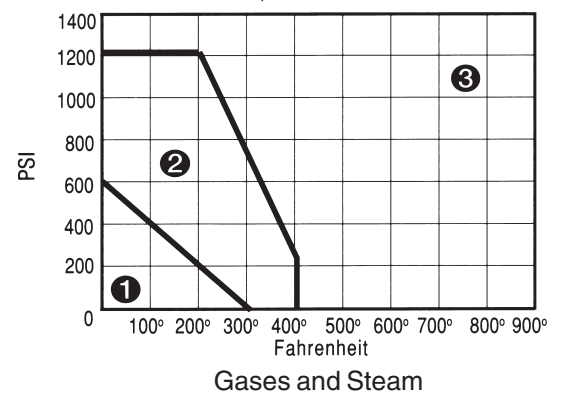
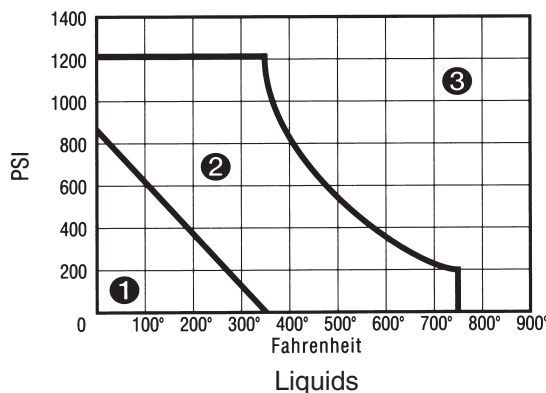

- ① In area one, the gasket material is suitable using common installation practices subject to chemical compatibility.
- ② In area two, appropriate measures are necessary for installation of the gasket to insure maximum performance. Please call APG or Thermoseal Technical Support Service for assistance.
- ③ In area three, DO NOT INSTALL GASKETS in these applications without first contacting APG or Thermoseal Technical Support Service.

Note: Manufacturers' brochures are available from APG if more technical information is required. Please inquire.



STYLE 0KC7400 KLINGER®sil C-7400

Synthetic fiber; EPDM binder; moderate caustics and acids; good oil swell characteristics; excellent aging properties; good in steam. Tensile strength 1600 PSI (ASTM F152 Cross Grain). Change in tensile strength 50% maximum decrease (ASTM F152). ASTM F102 Line Call Out F712441B3E46M5.

Size	Part Number
*1/64" x 60" x 180"	0KC740031x60x180
1/32" x 60" x 180"	
*3/64" x 60" x 180"	
1/16" x 60" x 180"	0KC740062x60x180
*3/32" x 60" x 180"	
*1/8" x 60" x 180"	

* Not an APG stock item. Special order.

Note: Longest lengths stocked by APG are indicated. Shorter lengths always available.

C-7400
Pressure and
Temperature
Graphs

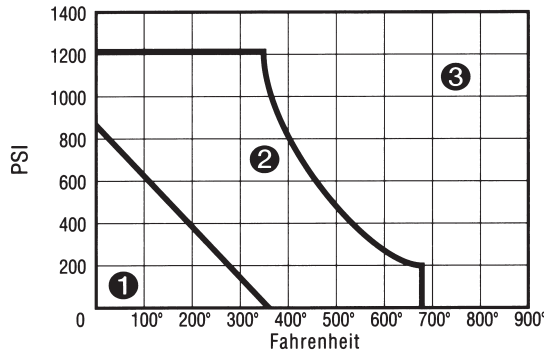

Liquids

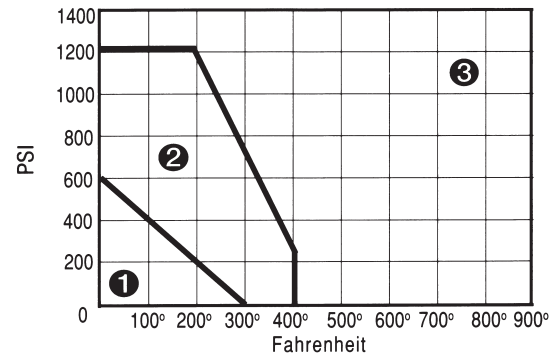

Gases and Steam

STYLE 0KC8200 KLINGER®sil C-8200

Synthetic fiber; hypalon binder; acid resistant; good oil-fuel resistance; good gas sealability; no color added. Tensile strength 1500 PSI typical (ASTM F152 Cross Grain). ASTM F102 Line Call Out F712000B6#00M5.

Size	Part Number
1/32" x 60" x 78.5"	0KC8200031x60x78.5
1/16" x 60" x 78.5"	0KC8200062x60x78.5
*3/32" x 60" x 78.5"	
1/8" x 60" x 78.5"	0KC8200125x60x78.5

* Not an APG stock item. Special order.

Note: Longest lengths stocked by APG are indicated. Shorter lengths always available.

C-8200
Pressure and
Temperature
Graphs

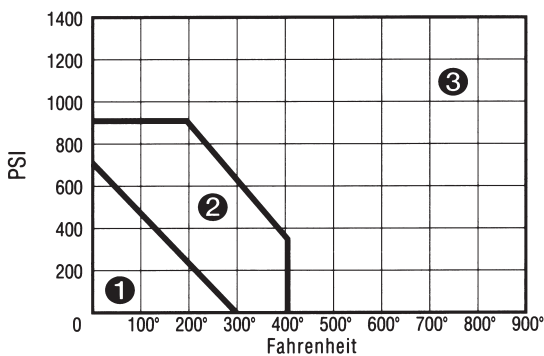

Liquids

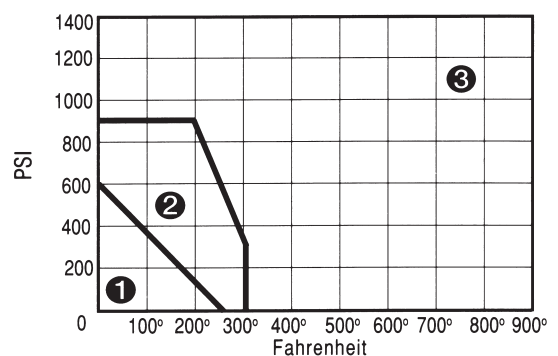

Gases and Steam

- ① In area one, the gasket material is suitable using common installation practices subject to chemical compatibility.
- ② In area two, appropriate measures are necessary for installation of the gasket to insure maximum performance. Please call APG or Thermoseal Technical Support Service for assistance.
- ③ In area three, DO NOT INSTALL GASKETS in these applications without first contacting APG or Thermoseal Technical Support Service.

Note: Manufacturers' brochures are available from APG if more technical information is required. Please inquire.



STYLE 0KSOFTCHEM

TherMOseal™ soft-chem™

Expanded PTFE material; excellent resistance to chemical attack; high creep resistance, high compressibility; superior memory characteristics. Tensile strength 1500 psi (ASTM F152). Compressibility 60% (ASTM F36J). Recovery 12% minimum (ASTM F36A).

Size	Part Number
*.5mm X 60" X 60"	OKSOFTCHEM062X60X60
*1mm x 60" x 60"	
1/16" x 60" x 60"	
1/8" X 60" X 60"	
*1/4 X 60" X 60"	

* Not an APG stock item. Special order.

soft-chem™
Pressure and
Temperature
Graph

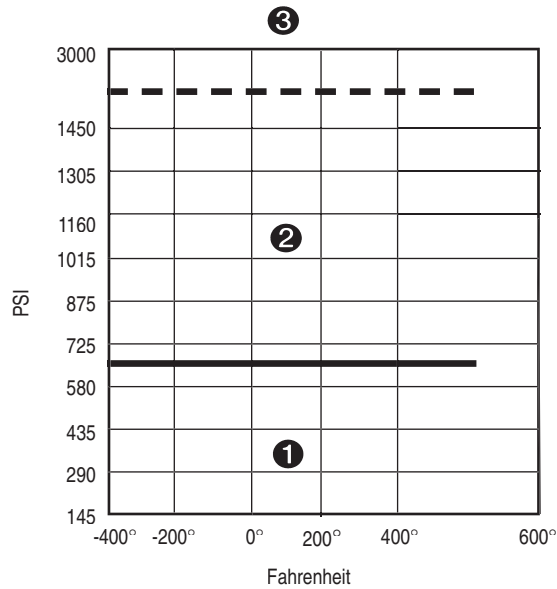

- ① In area one, the gasket material is suitable using common installation practices subject to chemical compatibility.
- ② In area two, appropriate measures are necessary for installation of the gasket to insure maximum performance. Please call APG or TherMOseal Technical Support Service for assistance.
- ③ In area three, DO NOT INSTALL GASKETS in these applications without first contacting APG or TherMOseal Technical Support Service.

Note: Manufacturers' brochures are available from APG if more technical information is required. Please inquire.

STYLE 0KPSS

TherMOseal™ Milam Laminate PSS

High quality mica sheet laminated on pegged stainless steel insert. Suitable for use in hot, dry gas applications such as exhaust manifolds, turbines, turbo chargers, and air heat exchangers. Compressibility (ASTM F36A) 12-15%. Recovery 50-55%. Tang insert stainless steel AISI 316 (Thickness .004"). Continuous service temperature 1652°F maximum. Gas leakage DIN 3535/4 >100ml/min. Internal pressure 29 psi maximum. Stress 14,503 psi maximum. Color - metallic tan.

Size	Part Number
1.3mm X 40" X 47"	OKPSS1301.3X40X47
*1/16" X 40" X 47"	
1/8" X 40" X 47"	

* Not an APG stock item. Special order.

**Special Needs?
Just ask. We can help!**



STYLE 0KTOPCHEM

KLINGER®top-chem-2000

PTFE gasket material with nearly universal application. Excellent chemical resistance to acidic and alkaline attack. Excellent mechanical properties at high temperatures and surface loads. Only PTFE gasket material with a Fire Test Certificate (criteria of API 6FA to ANSI Class 300 pressure rating). Components fully compatible with FDA requirements. Broad application in the chemical and petrochemical industries and in chemical tank transportation. Can be specified in steam services and wherever emission containment is required. Compressibility 2% (ASTF36J). Recovery 55% (ASTM F36A).

Size	Part Number
*1.0mm x 55" x 55"	OKTOPCHEM062X55X55
1/16" x 55" x 55"	
*.079" x 55" x 55"	OKTOPCHEM125X55X55
1/8" x 55" x 55"	

* Not an APG stock item. Special order.

KLINGER®top-chem-2000
Pressure and
Temperature
Graph

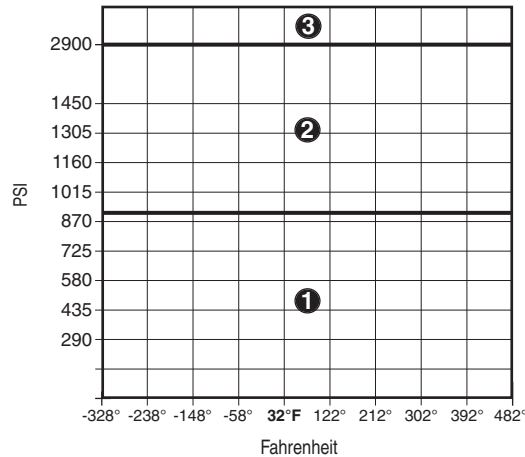

STYLE 0KTOP2006

KLINGER®top-chem-2006

Not an APG stock item.
Special Order

PTFE material with good resistance in strong alkaline applications. Broad range of applications in the chemical process industries. Good mechanical properties at medium and low temperatures and surface loads. Free from pigments, so is well suited for food processing and pharmaceutical services. Compressibility 4% (ASTM F36J). Recovery 40% (ASTM F36J).

KLINGER®top-chem-2006
Pressure and
Temperature
Graph

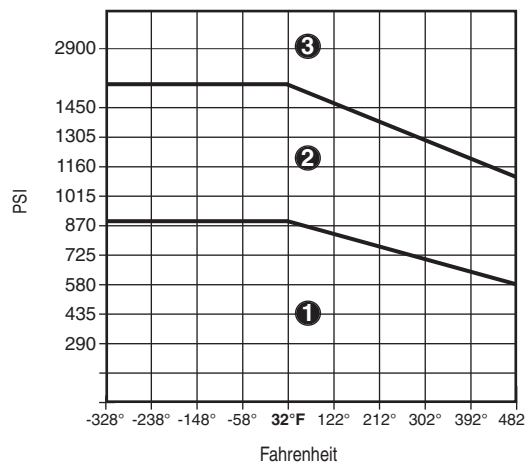

- ① In area one, the gasket material is suitable using common installation practices subject to chemical compatibility.
- ② In area two, appropriate measures are necessary for installation of the gasket to insure maximum performance. Please call APG or Thermoseal Technical Support Service for assistance.
- ③ In area three, DO NOT INSTALL GASKETS in these applications without first contacting APG or Thermoseal Technical Support Service.

Note: Manufacturers' brochures are available from APG if more technical information is required. Please inquire.



Thermoseal Inc.

KLINGER®sil CHEMICAL RESISTANCE CHART

The information in this chart should only be used as a general rule to the selection of a suitable material. Please contact Thermoseal Inc.'s Technical Service Department if you have any questions.

A: Suitable for application.

B: Suitability depends on operating conditions

C: Not suitable.

	4201	4300 4401	4408 4409	4324	4433 4430	4439	4500	4509	5400	6327 6400	7400	8200
Acetaldehyde	B	B	B	B	B	B	B	B	C	B	B	A
Acetic Acid 100%	A	A	A	A	A	C	A	C	B	B	B	A
Acetic Acid 10%	A	A	C	A	A	C	A	C	A	A	A	A
Acetic Ether	B	B	B	B	B	B	B	B	B	B	B	B
Acetone	B	B	B	B	B	B	B	B	B	A	A	A
Acetylene	A	A	A	A	A	A	A	A	A	A	A	A
Adipic Acid	A	A	A	A	A	A	A	A	A	A	A	A
Air	A	A	A	A	A	A	A	A	A	A	A	A
Alum	A	A	B	A	A	B	A	B	A	A	A	A
Aluminum Acetate	A	A	B	A	A	B	A	B	A	A	A	A
Aluminum Chloride	A	A	B	A	A	B	A	B	A	A	A	A
Ammonia	A	A	A	A	A	A	A	A	A	B	A	A
Ammonium Bicarbonate	A	A	A	A	A	A	A	A	A	A	A	A
Ammonium Chloride	A	A	C	A	A	C	A	C	A	A	A	A
Ammonium Diphosphate	A	A	A	A	A	A	A	A	A	A	A	A
Ammonium Hydroxide	B	B	B	A	A	B	A	B	B	B	B	A
Amyl Acetate	B	B	B	B	B	B	B	B	A	B	B	B
Aniline	C	C	C	C	C	C	C	C	C	B	B	C
Aviation fuels	A	A	A	A	A	A	A	A	A	C	C	A
Barium Chloride	A	A	A	A	A	A	A	A	A	A	A	A
Benzene	A	A	A	A	A	A	A	A	B	C	C	A
Benzoic Acid	B	B	B	B	B	B	A	B	A	B	B	A
Boiler Feeder Water	A	A	A	A	A	A	A	A	A	A	A	A
Boric Acid	A	A	A	A	A	A	A	A	A	A	A	A
Butane	A	A	B	A	A	B	A	B	A	C	C	A
Butanone (MEK)	B	B	B	B	B	B	B	B	C	C	C	B
Butyl Acetate	B	B	B	B	B	B	B	B	B	B	B	B
Butyl Alcohol (Butanol)	A	A	A	A	A	A	A	A	A	A	A	A
Butyric Acid	A	A	A	A	A	A	A	A	A	A	A	A
Calcium Chloride	A	A	B	A	A	B	A	B	A	A	A	A
Calcium Hydroxide	A	A	A	A	A	B	A	B	A	A	A	A
Calcium Hypochlorite	A	A	C	A	A	C	A	C	B	A	A	A
Carbon Dioxide	A	A	A	A	A	A	A	A	A	A	A	A
Carbon Disulfide	C	C	C	C	C	C	B	C	B	C	C	C
Carbon Tetrachloride	B	B	B	B	B	B	B	B	C	C	C	C
Caster Oil	A	A	A	A	A	A	A	A	A	B	B	A
Chlorine (Dry)	A	A	C	A	A	C	A	C	A	B	B	A
Chlorine (Wet)	C	B	C	B	B	C	C	C	C	B	C	B
Chloroform	B	B	B	B	B	B	C	B	C	C	C	C
Chromic Acid	C	B	C	C	C	C	B	C	C	C	C	B
Citric Acid	A	A	C	A	A	C	A	C	A	A	A	A
Clophen T64	B	B	B	B	B	B	B	B	A	C	C	B
Condensate	A	A	A	A	A	A	A	A	A	A	A	A
Copper Sulfate	A	A	A	A	A	A	A	A	A	A	A	A
Creosote	C	C	C	C	C	C	C	C	B	B	B	C
Cresol	B	B	B	B	B	B	B	B	B	B	B	B
Cyclohexanol	A	A	A	A	A	A	A	A	A	B	B	A
Decalin	A	A	A	A	A	A	A	A	B	C	C	A
Dibenzylether	C	C	C	C	C	C	C	C	C	C	C	C
Dibutylphthalate	A	A	A	A	A	A	A	A	B	C	C	A
Diesel Oil	A	A	A	A	A	A	A	A	B	C	C	A
Dimethylformamide	C	C	C	C	C	C	C	C	C	C	C	C
Diphyl (Dowtherm A)	A	A	A	A	A	A	A	A	B	C	C	A



Thermoseal Inc.

KLINGER®sil CHEMICAL RESISTANCE CHART

The information in this chart should only be used as a general rule to the selection of a suitable material. Please contact Thermoseal Inc.'s Technical Service Department if you have any questions.

A: Suitable for application.

B: Suitability depends on operating conditions

C: Not suitable.

	4201	4300 4401	4408 4409	4324	4433 4430	4439	4500	4509	5400	6327 6400	7400	8200
Dye Liquors (Alkaline, Neutral, Acid)	B	A	A	B	A	C	A	C	A	A	A	A
Ethane	A	A	C	A	B	C	A	C	A	A	A	A
Ethyl Acetate	B	B	B	B	B	B	B	B	B	B	B	B
Ethyl Alcohol (Ethanol)	A	A	A	A	A	A	A	A	A	A	A	A
Ethyl Chloride	B	B	B	B	B	B	B	B	B	C	C	B
Ethylene	A	A	C	A	A	C	A	C	A	A	A	A
Ethylene Chloride	C	C	C	C	C	C	C	C	B	B	A	A
Ethylene Glycol	A	A	A	A	A	A	A	A	A	A	A	A
Ethyl Ether	B	A	C	A	B	C	A	C	A	B	B	A
Freon 12	A	A	A	A	A	C	A	C	A	C	C	A
Freon 22	B	A	C	A	B	C	A	C	A	C	C	A
Formaldehyde	A	A	A	A	A	A	A	A	A	A	A	A
Formic Acid 10%	A	A	C	A	A	C	A	C	A	A	A	A
Formic Acid 85%	C	B	C	B	B	C	B	C	B	B	B	A
Glycerine	A	A	A	A	A	A	A	A	A	A	A	A
Heating Oil	A	A	A	A	A	A	A	A	B	C	C	A
Heptane	A	A	A	A	A	A	A	A	A	C	C	A
Hydraulic Oil (Glycol Base)	A	A	A	A	A	A	A	A	A	A	A	A
Hydraulic Oil (Mineral)	A	A	A	A	A	A	A	A	A	C	C	A
Hydraulic Oil (Phosphate Ester Based)	B	B	B	B	B	B	B	B	B	B	B	B
Hydrochloric Acid 20%	C	B	C	B	B	C	B	C	B	C	C	A
Hydrochloric Acid 37%	C	C	C	C	C	C	C	C	C	C	C	A
Hydrochloric Acid 10%	C	C	C	C	C	C	C	C	B	C	C	A
Hydrofluoric Acid 40%	C	C	C	C	C	C	C	C	C	C	C	C
Hydrogen	A	A	C	A	A	C	A	C	A	A	A	A
Hydrogen Peroxide (Up To 6% W.W.)	A	A	C	A	A	C	A	C	A	A	A	A
Hydrogen Chloride (Dry)	A	A	C	A	A	C	A	C	A	A	A	A
Iso-octane	A	A	A	A	A	A	A	A	A	B	B	A
Isopropyl Alcohol	A	A	A	A	A	A	A	A	A	A	A	A
Kerosene	A	A	A	A	A	A	A	A	A	C	C	A
Lactic Acid 50%	A	A	C	A	A	C	A	C	A	A	A	A
Linseed Oil	A	A	A	A	A	A	A	A	A	B	B	A
Magnesium Sulfate	A	A	A	A	A	A	A	A	A	A	A	A
Malic Acid	A	A	A	A	A	A	A	A	A	A	A	A
Methane	A	A	C	A	A	C	A	C	A	A	A	A
Methyl Alcohol	A	A	A	A	A	A	A	A	A	A	A	A
Methyl Chloride	B	B	B	B	B	C	B	C	B	C	C	B
Methylene Chloride	C	C	C	C	C	C	C	C	C	B	C	B
Methyl Ethyl Ketone	B	B	B	B	B	B	B	B	B	C	C	B
Mineral Oil	A	A	A	A	A	A	A	A	A	C	B	A
Mineral Oil, ASTM 1	A	A	A	A	A	A	A	A	A	B	B	A
Monochloromethane	B	B	C	B	B	C	B	C	B	C	C	B
Nitrogen	A	A	A	A	A	A	A	A	A	A	A	A
Naphtha	A	A	A	A	A	A	A	A	B	C	C	A
Nitric Acid 20%	C	C	C	C	C	C	C	C	C	C	C	A
Nitric Acid 40%	C	C	C	C	C	C	C	C	C	C	C	A
Nitric Acid 96%	C	C	C	C	C	C	C	C	C	C	C	C
Octane	A	A	A	A	A	A	A	A	B	C	B	A
Oleic Acid	A	A	A	A	A	A	A	A	A	A	A	A
Oxalic Acid	B	B	B	B	B	B	B	B	B	C	C	A



Thermoseal Inc.

KLINGER®sil CHEMICAL RESISTANCE CHART

The information in this chart should only be used as a general rule to the selection of a suitable material. Please contact Thermoseal Inc.'s Technical Service Department if you have any questions.

A: Suitable for application.

B: Suitability depends on operating conditions

C: Not suitable.

	4201	4300 4401	4408 4409	4324	4433 4430	4439	4500	4509	5400	6327 6400	7400	8200
Palmitic Acid	A	A	A	A	A	A	A	A	A	A	A	A
Pentane	A	A	A	A	A	A	A	A	A	C	C	A
Perchloroethylene	B	B	B	B	B	B	B	B	B	C	C	B
Petroleum	A	A	A	A	A	A	A	A	A	B	B	A
Petroleum Ether	A	A	A	A	A	A	A	A	A	B	B	A
Phenol	C	C	C	C	C	C	C	C	B	B	B	B
Phosphoric Acid	A	A	A	A	A	A	A	A	A	A	B	A
Phthalic Acid	A	A	A	A	A	A	A	A	A	A	A	A
Potassium Acetate	A	A	A	A	A	A	A	A	A	A	A	A
Potassium Carbonate	A	A	A	A	A	A	A	A	A	A	A	A
Potassium Chlorate	A	A	A	A	A	A	A	A	A	A	A	A
Potassium Chloride	A	A	A	A	A	A	A	A	A	A	A	A
Potassium Cyanide	A	A	A	A	A	A	A	A	A	A	A	A
Potassium Dichromate	A	A	A	A	A	A	A	A	A	A	A	A
Potassium Hydroxide	C	B	B	C	B	B	A	A	B	B	B	A
Potassium Hypochlorite	A	A	A	A	A	A	A	A	A	A	A	A
Potassium Nitrate	A	A	A	A	A	A	A	A	A	A	A	A
Potassium Permanganate	A	A	A	A	A	A	A	A	A	A	A	A
Producer Gas	A	A	C	A	B	C	A	C	A	B	A	A
Propane	A	A	C	A	B	C	A	C	A	B	B	A
Pydrol	A	A	A	A	A	A	A	A	A	C	C	B
Pyridine	C	C	C	C	C	C	C	C	C	B	B	C
Rape Seed Oil	A	A	A	A	A	A	A	A	A	B	B	B
Silicone Oil	A	A	A	A	A	A	A	A	A	A	A	A
Sea Water	A	A	B	A	A	B	A	B	A	A	A	A
Sodium Aluminate	A	A	A	A	A	A	A	A	A	A	A	A
Sodium Bicarbonate	A	A	A	A	A	A	A	A	A	A	A	A
Sodium Bisulphite	A	A	B	A	A	B	A	B	A	A	A	A
Sodium Chloride	A	A	A	A	A	A	A	A	A	A	A	A
Sodium Hydroxide	C	B	B	C	B	B	A	A	B	B	A	A
Sodium Silicate	A	A	A	A	A	A	A	A	A	A	A	A
Sodium Sulphate	A	A	A	A	A	A	A	A	A	A	A	A
Sodium Sulphide	A	A	A	A	A	A	A	A	A	A	A	A
Steam	B	B	A	B	A	A	A	A	B	B	B	B
Stearic Acid	A	A	A	A	A	A	A	A	A	A	A	A
Sulphur Dioxide	C	C	C	C	C	C	B	C	B	B	B	A
Sulphuric Acid 20%	C	C	C	C	C	C	C	C	B	C	C	A
Sulphuric Acid 50%	C	C	C	C	C	C	C	C	C	C	C	A
Sulphuric Acid 96%	C	C	C	C	C	C	C	C	C	C	C	A
Sulphurous Acid	C	B	C	C	C	C	B	C	B	B	B	B
Tannic Acid	A	A	A	A	A	A	A	A	A	A	A	A
Tartaric Acid	A	A	A	A	A	A	A	A	A	A	A	A
Tetrachlorethane	B	B	B	B	B	B	B	B	B	C	C	B
Tetralin	A	A	A	A	A	A	A	A	B	C	C	A
Toluene	A	A	A	A	A	A	A	A	B	C	C	A
Town's Gas	A	A	C	A	A	C	A	C	A	B	B	A
Transformer Oil	A	A	A	A	A	A	A	A	A	B	B	B
Trichlorethylene	B	B	B	B	B	B	B	B	B	C	C	B
Turpentine	A	A	A	A	A	A	A	A	B	C	C	B
Vinyl Acetate	A	A	A	A	A	A	A	A	B	C	C	A
Water	A	A	A	A	A	A	A	A	A	A	A	A
White Spirit	A	A	A	A	A	A	A	A	A	C	C	A
Xylene	A	A	A	A	A	A	A	A	B	C	C	A



Garlock

Sealing Technologies®

Non-Asbestos Gasket Materials

STYLE 0G2900 Garlock Style 2900

Aramid and mineral fiber; nitrile binder. Good for water, aliphatic hydrocarbons, oils, gasoline. Temperature – Maximum: 700° F, Minimum: -40° F, Continuous Maximum: 400° F. Maximum Pressure: 1000 psig. Sealability ASTM Fuel A 0.25 ml/hr. (ASTM F37B). Creep relaxation: 25% (ASTM F38B). Tensile strength 1500 psi (ASTM F152 across grain). Color: Black.

Size	Part Number
1/64" x 60" x 120"	0G2900015x60x120
1/32" x 60" x 120"	0G2900031x60x120
*3/64" x 60" x 120"	
1/16" x 60" x 120"	0G2900062x60x120
3/32" x 60" x 120"	0G2900093x60x120
1/8" x 60" x 120"	0G2900125x60x120

*Not an APG stock item. Special order.

Note: Longest lengths stocked by APG are indicated. Shorter lengths always available.

STYLE 0G3000 BLUE-GARD® 3000

Aramid fiber; nitrile binder. Good for water, aliphatic hydrocarbons, oils, gasoline. Temperature – Maximum: 700° F, Minimum: -40° F, Continuous Maximum: 400° F. Maximum Pressure: 1000 psig. Sealability ASTM Fuel A 0.2 ml/hr, nitrogen 0.6 ml/hr (ASTM F37B). Creep relaxation 21% (ASTM F38). Tensile strength 2250 psi (ASTM F152 across grain). Color: Blue.

Size	Part Number
1/64" x 60" x 180"	0G3000015x60x180
*1/64" x 150" x 150"	
1/32" x 60" x 180"	0G3000031x60x180
*1/32" x 150" x 150"	
*3/64" x 60" x 180"	
*3/64" x 150" x 150"	
1/16" x 60" x 180"	0G3000062x60x180
*1/16" x 150" x 150"	
3/32" x 60" x 180"	0G3000093x60x180
*3/32" x 150" x 150"	
1/8" x 60" x 180"	0G3000125x60x180
*1/8" x 150" x 150"	
3/16" x 60" x 60"	0G3000187x60x60
1/4" x 60" x 60"	0G3000250x60x60

*Not an APG stock item. Special order.

Note: Longest lengths stocked by APG are indicated. Shorter lengths always available.



STYLE 0G3200 BLUE-GARD® 3200

Aramid fiber; SBR binder. Good for water, saturated steam, inert gases. Temperature – Maximum: 700° F, Minimum: -40° F, Continuous Maximum: 400° F. Maximum Pressure: 1200 psig. Sealability ASTM Fuel A 0.1 ml/hr, nitrogen 0.4 ml/hr (ASTM F37B). Creep relaxation 18% (ASTM F38). Tensile strength 2250 psi (ASTM F152 across grain). Color: Off-White. Meets Mil-G-24696B

Size	Part Number
1/64" x 60" x 180"	0G3200015x60x180
*1/64" x 150" x 150"	
1/32" x 60" x 180"	0G3200031x60x180
*1/32" x 150" x 150"	
*3/64" x 60" x 180"	
*3/64" x 150" x 150"	
1/16" x 60" x 180"	0G3200062x60x180
*1/16" x 150" x 150"	
3/32" x 60" x 180"	0G3200093x60x180
*3/32" x 150" x 150"	
1/8" x 60" x 180"	0G3200125x60x180
*1/8" x 150" x 150"	

*Not an APG stock item. Special order.
Note: Longest lengths stocked by APG are indicated. Shorter lengths always available.

STYLE 0G3300 BLUE-GARD® 3300

Aramid fiber; neoprene binder. Good for water, saturated steam, refrigerants, oils, fuels. Temperature – Maximum: 700° F, Minimum: -40° F, Continuous Maximum: 400° F. Maximum Pressure: 1200 psig. Sealability ASTM Fuel A 0.2 ml/hr, nitrogen 1.0 ml/hr (ASTM F37B). Creep relaxation 18% (ASTM F38). Tensile strength 2800 psi (ASTM F152 across grain). Color: Black.

Size	Part Number
1/64" x 60" x 180"	0G3300015x60x180
*1/64" x 150" x 150"	
1/32" x 60" x 180"	0G3300031x60x180
*1/32" x 150" x 150"	
*3/64" x 60" x 180"	
*3/64" x 150" x 150"	
1/16" x 60" x 180"	0G3300062x60x180
*1/16" x 150" x 150"	
3/32" x 60" x 180"	0G3300093x60x180
*3/32" x 150" x 150"	
1/8" x 60" x 180"	0G3300125x60x180
*1/8" x 150" x 150"	

*Not an APG stock item. Special order.
Note: Longest lengths stocked by APG are indicated. Shorter lengths always available.

STYLE 0G3700 BLUE-GARD® 3700

Aramid fiber; EPDM binder. Good for water, saturated steam, mild chemicals. Temperature – Maximum: 700° F, Minimum: -40° F, Continuous Maximum: 400° F. Maximum Pressure: 1200 psig. Sealability ASTM Fuel A 0.1 ml/hr, nitrogen 0.7 ml/hr (ASTM F37B). Creep relaxation 25% (ASTM F38). Tensile strength 2500 psi (ASTM F152 across grain). Color: Light Grey.

Size	Part Number
1/64" x 60" x 180"	0G3700015x60x180
*1/64" x 150" x 150"	
1/32" x 60" x 180"	0G3700031x60x180
*1/32" x 150" x 150"	
*3/64" x 60" x 180"	
*3/64" x 150" x 150"	
1/16" x 60" x 180"	0G3700062x60x180
*1/16" x 150" x 150"	
3/32" x 60" x 180"	0G3700093x60x180
*3/32" x 150" x 150"	
1/8" x 60" x 180"	0G3700125x60x180
*1/8" x 150" x 150"	

*Not an APG stock item. Special order.
Note: Longest lengths stocked by APG are indicated. Shorter lengths always available.

STYLE 0G3500 GYLON® 3500

Composition: PTFE with silica. Good for strong acids (except hydrofluoric), solvents, hydrocarbons, water, steam, or chlorine. Temperature – Maximum: 500° F, Minimum: -350° F. Maximum pressure: 1200 psig. Sealability ASTM Fuel A 0.22 ml/hr (ASTM F37B). Creep relaxation: 18% (ASTM F38B). Tensile strength 2000 psi (ASTM D1708). Color: Fawn with black brand.

Size	Part Number
1/16" x 60" x 60"	0G3500062x60x60
1/8" x 60" x 60"	0G3500125x60x60

Note: Additional sizes available by special order. Please inquire.

STYLE 0G3504 GYLON® 3504

Composition: PTFE with glass microspheres. Good for moderate concentrations of acids and some caustics, hydrocarbons, solvents, water, refrigerants, cryogenics, or hydrogen peroxide. Temperature – Maximum: 500° F, Minimum: -350° F. Maximum pressure: 1200 psig. Sealability ASTM Fuel A 0.12 ml/hr (ASTM F37B). Creep relaxation: 40% (ASTM F38B). Tensile strength 2000 psi (ASTM D1708). Color: Blue with black brand.

Size	Part Number
1/16" x 60" x 60"	0G3504062x60x60
1/8" x 60" x 60"	0G3504125x60x60

Note: Additional sizes available by special order. Please inquire.

STYLE 0G3510 GYLON® 3510

Composition: PTFE with barium sulfate. Good for strong caustics, moderate acids, chlorine, gases, water, steam, hydrocarbons, and aluminum fluoride. Temperature – Maximum: 500° F, Minimum: -350° F. Maximum pressure: 1200 psig. Sealability ASTM Fuel A 0.04 ml/hr (ASTM F337B). Creep relaxation: 11% (ASTM F38B). Tensile strength 2000 psi (ASTM D1708). Color: Off-White with black brand.

Size	Part Number
1/16" x 60" x 60"	0G3510062x60x60
1/8" x 60" x 60"	0G3510125x60x60

Note: Additional sizes available by special order. Please inquire.

Note: Manufacturers' brochures are available from APG if more technical information is required. Please inquire.



Non-Asbestos Gasket Materials

STYLE 0782

**Plant Fibre Rubber Beater Saturated
(Interface Solutions CS-301)**

Made from cellulose fibre, cork, and styrene butadiene rubber (SBR). A tendency to swell moderately without disintegrating in water or oil makes this fibre sheet a dependable seal in services not involving aromatic fuels and solvents. Tensile strength minimum 700 PSI. Temperatures to 300°F.

Size	Part Number
1/64" x 40"	0782015x40
1/32" x 40"	0782031x40
1/16" x 40"	0782062x40

STYLE 0783

**Plant Fibre Buna-N Beater Saturated
(Interface Solutions CN-705)**

Made from cellulose fibre, cork, and Buna-N. It is generally suitable for oil, gasoline, and water services. Combines high compressibility and high crush strength. Tensile strength minimum 1000 PSI. Temperatures to 300°F.

Size	Part Number
1/64" x 40"	0783015x40
1/32" x 40"	0783031x40
1/16" x 40"	0783062x40

STYLE 0792

**Cork and Neoprene Medium Hardness
(Amorim Industrial Solutions DC-100)**

A neoprene rubber sheet to which very fine cork particles have been added to create a homogeneous material with great compressibility combined with the resiliency of neoprene. A general purpose gasket and sealing material that has high cork content, minimum side flow. An excellent material for very narrow flange gaskets and for low bolt load applications. For oil, non-aromatic petroleum derivatives, fatty oils, and solvents (except chlorinated, aromatic, or ketone types). Shore A Hardness 55 to 70. Temperatures to 275°F.

Size	Part Number
1/32" x 36" x 36"	0792031x36x36
1/16" x 36" x 36"	0792062x36x36
1/8" x 36" x 36"	0792125x36x36
3/16" x 36" x 36"	0792187x36x36
1/4" x 36" x 36"	0792250x36x36
5/16" x 36" x 36"	0792312x36x36
3/8" x 36" x 36"	0792375x36x36
1/2" x 36" x 36"	0792500x36x36

STYLE 0792A

**Cork and Neoprene Soft
(Amorim Industrial Solutions DC-179)**

Same type material as Style 0792, only slightly softer, giving greater compressibility. Shore A Hardness 50 to 65.

Size	Part Number
1/32" x 36" x 36"	0792A031x36x36
1/16" x 36" x 36"	0792A062x36x36
3/32" x 36" x 36"	0792A093x36x36
1/8" x 36" x 36"	0792A125x36x36
3/16" x 36" x 36"	0792A187x36x36
1/4" x 36" x 36"	0792A250x36x36
5/16" x 36" x 36"	0792A312x36x36
3/8" x 36" x 36"	0792A375x36x36
*1/2" x 36" x 36"	

* Not an APG stock item. Special order.

Refer to Product Index for Similar Products

**STYLE 0793****Cork and Buna-N Medium Hardness
(Amorim Industrial Solutions NC-710)**

Buna-N sheet with fine particles of cork added, providing a homogeneous material with great compressibility combined with maximum resiliency of Buna-N. Excellent for narrow flange gaskets and for low bolt load applications. For oil and non-aromatic petroleum derivatives. Shore A Hardness 55 to 70. Temperatures to 275°F.

Size	Part Number
1/32" x 36" x 36"	0793031x36x36
1/16" x 36" x 36"	0793062x36x36
1/8" x 36" x 36"	0793125x36x36
3/16" x 36" x 36"	0793187x36x36
1/4" x 36" x 36"	0793250x36x36
5/16" x 36" x 36"	0793312x36x36
3/8" x 36" x 36"	0793375x36x36
1/2" x 36" x 36"	0793500x36x36

STYLE 0793B**Cork and Buna-N Firm
(Amorim Industrial Solutions NC-711)**

Same type material as Style 0793, except firm. Shore A Hardness 70 to 85.

Size	Part Number
1/32" x 36" x 36"	0793B031x36x36
1/16" x 36" x 36"	0793B062x36x36
1/8" x 36" x 36"	0793B125x36x36
1/4" x 36" x 36"	0793B250x36x36
*5/16" x 36" x 36"	
*3/8" x 36" x 36"	
*1/2" x 36" x 36"	

* Not an APG stock item. Special order.

STYLE 0794**Cork and Synthetic Sponge Rubber Adhesive
Backed (Day International DK-153T)**

Cork and sponge rubber composition that combines lasting resiliency with high surface friction. It is used to eliminate squeaks, cushion fragile parts, make slippery surfaces non-skid, and to absorb shock or relative motion between adjoining parts of an assembly. It has a strong, pressure-sensitive adhesive, protected with a polyethylene fiber.

Size	Part Number
1/16" x 36"	0794062x36
1/8" x 36"	0794125x36

STYLE 0794FC**Cork and Synthetic Sponge Rubber Tape,
Adhesive Backed (Day International DK-153T)**

Same as Style 0794, except in tape form. Material is slit to your required widths.

STYLE 0N8051**Impervapac Nitrile Binder
(Interface Solutions N-8051)**

Recommended for low internal pressure and low flange pressure applications (up to 2000 PSI). Moderate oil resistance. Nitrile Butadiene binder. Minimum tensile strength 400 PSI.

Size	Part Number
1/16" x 40"	0N8051062x40
*1/32" x 40"	
*3/64" x 40"	
*1/16" x 40"	

* Not an APG stock item. Special order.

Refer to Product Index for Similar Products



STYLE 0N8090

**Syntheseal Latent Cure Nitrile Binder
(Interface Solutions N-8090)**

Syntheseal non-asbestos gasket materials are designed to be a direct substitute for asbestos-containing materials. Style 0N8090 is a reinforced cellulose fiber and a Latent Cure nitrile butadiene binder. The Latent Cure system is formulated for initial conformability which helps seal rough flanges. The presence of heat in the application activates ingredients which vulcanize the material to provide the benefits of Fully Cured products. This provides Style 0N8090 with outstanding sealing characteristics. Excellent oil resistance. Temperatures below 350°F. Minimum tensile strength 2000 PSI.

Size	Part Number
1/64" x 40"	0N8090015x40
*.020" x 40"	0N8090031x40
1/32" x 40"	
*.039" x 40"	0N8090062x40
*3/64" x 40"	
1/16" x 40"	

* Not an APG stock item. Special order.

STYLE 0N8092

**Syntheseal Fully Cured Nitrile Binder
(Interface Solutions N-8092)**

Syntheseal non-asbestos gasket materials are designed to be a direct substitute for asbestos-containing materials. Style 0N8092 is a reinforced cellulose fiber and a Fully Cured nitrile butadiene binder. The Fully Cured system contains rubber binders which are vulcanized during formulation or in subsequent processes for added initial strength and fluid resistance. Style 0N8092 excellent crush resistance at high flange pressures. For sealing oil, fuels, and water. Temperatures below 350°F. Minimum tensile strength 1600 PSI.

Size	Part Number
1/64" x 40"	0N8092015x40
*.020" x 40"	0N8092031x40
1/32" x 40"	
*.039" x 40"	0N8092062x40
*3/64" x 40"	
1/16" x 40"	

* Not an APG stock item. Special order.

STYLE 0S8091

**Syntheseal Latent Cure Styrene Butadiene
Binder (Interface Solutions S-8091)**

Syntheseal non-asbestos gasket materials are designed to be a direct substitute for asbestos-containing materials. Style 0S8091 is a reinforced cellulose fiber with a Controlled Swell Latent Cure Styrene Butadiene binder. Controlled Swell materials are Latent Cure products which use Styrene Butadiene Rubber (SBR) binders. Significant thickness increase occurs at the exposed initial edge of the gasket with many fluids, dramatically improving sealability. The heat of application then vulcanizes the material to limit further swelling and provide Fully Cured performance. For oils, fuels, and low-pressure steam. Temperatures below 350°F. Minimum tensile strength 1800 PSI.

Size	Part Number
*1/64" x 40"	
*.020" x 40"	
*1/32" x 40"	
*.039" x 40"	0S8091062x40
*3/64" x 40"	
1/16" x 40"	

* Not an APG stock item. Special order.



"America's Most Responsive Warehouse"

Let us show you why!

**STYLE 0TN9001****Thermo-Tork Latent Cure Nitrile Butadiene Binder (Interface Solutions TN-9001)**

Thermo-Tork materials are non-asbestos formulated and are designed to outperform many asbestos-containing products in a wide range of heavy-duty applications. Style 0TN9001 is aramid fiber with a Latent Cure nitrile butadiene binder. The Latent Cure system is formulated for initial conformability which helps seal rough flanges. The presence of heat in the application activates ingredients which vulcanize the material to provide the benefits of Fully Cured products. Style 0TN9001 is designed for heavy-duty applications up to 750°F. Excellent oil resistance. Minimum tensile strength 2000 PSI.

Size	Part Number
*1/64" x 40" *.020" x 40" *1/32" x 40"	
*.039" x 40" *3/64" x 40" 1/16" x 40"	0TN9001062x40

* Not an APG stock item. Special order.

STYLE 0TS9013**Thermo-Tork Latent Cure Styrene Binder (Interface Solutions TS-9013)**

Thermo-Tork materials are non-asbestos formulated and are designed to outperform many asbestos-containing products in a wide range of heavy-duty applications. Style 0TS9013 is a blend of cellulose and aramid fibers with a Latent Cure styrene binder. The Latent Cure system is formulated for initial conformability which helps seal rough flanges. The presence of heat in the application activates ingredients which vulcanize the material to provide the benefits of Fully Cured products. Style 0TS9013 is designed for heavy-duty applications up to 550°F. Recommended for water and oil applications. Minimum tensile strength 1200 PSI.

Size	Part Number
*1/64" x 40" *.020" x 40" 1/32" x 40"	0TS9013031x40
*.039" x 40" *3/64" x 40" 1/16" x 40"	0TS9013062x40

* Not an APG stock item. Special order.

STYLE 0TS9016**Thermo-Tork Fully Cured Styrene Binder (Interface Solutions TS-9016)**

Thermo-Tork materials are non-asbestos formulated and are designed to outperform many asbestos-containing products in a wide range of heavy-duty applications. Style 0TS9016 is a blend of cellulose and aramid fibers fully cured with a styrene binder. The Fully Cured system provides for maximum initial strength and fluid resistance. Style 0TS9016 is designed for heavy-duty applications up to 550°F. Recommended for water and oil applications. Good resistance to oils, yet offers the sealability of S.B.R. material. Minimum tensile strength 1800 PSI.

Size	Part Number
1/64" x 40" *.020" x 40" 1/32" x 40"	0TS9016015x40 0TS9016031x40
*.039" x 40" 3/64" x 40" *1/16" x 40"	0TS9016047x40

* Not an APG stock item. Special order.

In addition to the products in this catalog, APG supplies o-rings, industrial hose couplings, industrial glass, and much, much more! See pages 71 and 72.



Products

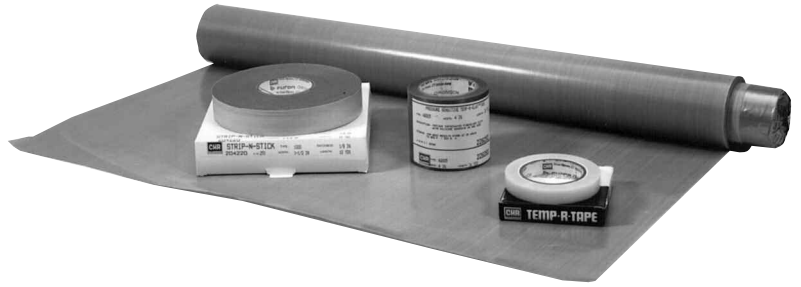

STYLE 12C100S 100S Strip-n-Stick®

Manufactured from CHR's COHRLastic® silicone rubber, in pressure sensitive tape form as a closed cell sponge. Sticks instantly without heat, water, or solvent catalyst. Pressure sensitive adhesive has excellent bond strength, yet can be easily removed. Silicone rubber has a unique chemical structure which gives it high temperature stability and overall inertness unavailable in any other elastomer. Excellent compression set resistance, electrical strength, and clean release. Tensile strength 65 PSI. Temperature range: -100°F to +500°F. Elongation 25%.

Size	Part Number
1/16" x 1/2" x 10YD	12C100S062x1/2
1/8" x 1/2" x 10YD	12C100S125x1/2
3/16" x 1/2" x 5YD	12C100S187x1/2
1/16" x 3/4" x 10YD	12C100S062x3/4
3/32" x 3/4" x 10YD	12C100S093x3/4
1/8" x 3/4" x 10YD	12C100S125x3/4
3/16" x 3/4" x 5YD	12C100S187x3/4
1/16" x 1" x 10YD	12C100S062x1
1/8" x 1" x 10YD	12C100S125x1
3/16" x 1" x 5YD	12C100S187x1
1/8" x 1 1/2" x 10YD	12C100S125x1 1/2
3/16" x 1 1/2" x 5YD	12C100S187x1 1/2
1/16" x 2" x 10YD	12C100S062x2
1/8" x 2" x 10YD	12C100S125x2
3/16" x 2" x 5YD	12C100S187x2

**STYLE 12C3TB
STYLE 12C5TB
STYLE 12C6TB
STYLE 12C10TB**

**Temp-R-Glas®
Fabrics,
Premium Grade**

Approx. Thickness	Width/Length	Approx. Weight (lbs/yd ²)	Avg Dielectric Strength (volts/mil. 1/4" electrodes)	Part Number
.003"	36" x 36 YD.	.250	550	12C3TB
.005"	36" x 36 YD.	.440	450	12C5TB
.006"	36" x 36 YD.	.540	600	12C6TB
*.008"	36" x 36 YD.	.690	450	12C10TB
.010"	36" x 36 YD.	.900	500	

Teflon® TFE impregnated fiberglass cloth. Combines a Teflon® surface with a variety of woven fabrics yielding a material that is tough, abrasion resistant, dimensionally stable and operational in both high and low temperature environments. Excellent break and tear strengths. Universal chemical inertness. Fiberglass restricts Teflon® cold flow and permits its use under compression load applications including conveyor belts (especially in high temperature environments), release surface and bleeding cloth in loading shops, and as an electrical laminate. Temperature range: -240°C to +316°C.

* Not an APG stock item. Special order.

**STYLE 12C3TA
STYLE 12C5TA**

**Temp-R-Glas®
Fabrics,
Premium Grade**

Approx. Thickness	Width/Length	Approx. Weight (lbs/yd ²)	Avg Dielectric Strength (volts/mil. 1/4" electrodes)	Part Number
.003"	36" x 36 YD.	.270	600	12C3TA
.005"	36" x 36 YD.	.505	500	12C5TA
*.006"	36" x 36 YD.	.570	650	
*.008"	36" x 36 YD.	.755	500	
*.010"	36" x 36 YD.	.980	550	

Same as above Standard Grade, but with higher lbs/yd² weights and dielectric strengths. Useful as slot liners in motors and as high temperature cable insulation.

* Not an APG stock item. Special order.



STYLE 12CA2005
STYLE 12CA2007
STYLE 12CA2008
STYLE 12CA2012

Temp-R-Glas® Tape

Manufactured from Teflon® TFE impregnated fiberglass fabric and high temperature silicone pressure sensitive adhesive. Fiberglass provides dimensional stability and restricts Teflon® cold flow under compressive load. It also increase tear strength and cut-through resistance. Chemically inert and wear resistant. Pressure sensitive adhesives stick instantly without heat, water, or solvent catalyst. Used on packaging equipment, such as L-sealers, heat sealers, blister and form-and-fill equipment, where the Teflon® surface provides quick release and smooth material flow and the fiberglass reinforcement insures durability. Also used as a non-stick, easily cleaned surface on chutes and work tables. Silicone adhesive. Temperature range: -100°F to 500°F. Elongation < 5%.

Approx. Thickness	Width/Length	Breaking Strength (lbs in width)	Part Number
.005"	1/2" x 36 YD	55	12CA2005x1/2
.005"	1" x 36 YD	55	12CA2005x1
.005"	1 1/2" x 36 YD	55	12CA2005x1-1/2
.005"	2" x 36 YD	55	12CA2005x2
.005"	3" x 36 YD	55	12CA2005x3
.007"	1/2" x 36 YD	145	12CA2007x1/2
.007"	1" x 36 YD	145	12CA2007x1
.007"	2" x 36 YD	145	12CA2007x2
.007"	4" x 36 YD	145	12CA2007x4
.008"	1/2" x 36 YD	150	12CA2008x1/2
.008"	3/4" x 36 YD	150	12CA2008x3/4
.008"	1 1/2" x 36 YD	150	12CA2008x1-1/2
.008"	2" x 36 YD	150	12CA2008x2
.012"	1/2" x 36 YD	325	12CA2012x1/2
.012"	1" x 36 YD	325	12CA2012x1
.012"	4" x 36 YD	325	12CA2012x4

Note: Above thicknesses and widths are stocked by APG. Others are available by special order.

STYLE 12CC

Temp-R-Tape® C

Manufactured from extruded Teflon® FEP and silicone pressure sensitive adhesive. Transparent tape with many properties similar to tapes manufactured from Teflon® TFE: non-stick surface, conformability, chemically inert. Highest electrical strength in volts per mil of all Temp-R-Tapes of Teflon®, permitting maximum electrical insulation with a minimum number of wraps. Ideal insulating material for coils and transformers. Of special interest is its transparency, which is useful for "see-through" identification on wiring harnesses. Thickness with adhesive - .003". Backing thickness - .002". Breaking strength - 8 lb/in width. Electric strength - 9,000 volts total. Temperature range: -100°F to 400°F. Elongation 275%.

Size	Part Number
1/2" x 36 YD	12CCx1/2
3/4" x 36 YD	12CCx3/4
1" x 36 YD	12CCx1
*1 1/2" x 36 YD	
*2" x 36 YD	

* Not an APG stock item. Special order.

STYLE 12CHM

Temp-R-Tape® HM Series

Manufactured from Teflon® TFE film which has been subjected to a unique manufacturing process that lowers elongation and increases breaking strength for easier handling. Chemically inert, weather resistant, stable, non-toxic, high temperature resistance, with anti-friction properties. Applications include roll covering on plastic extruder, masking during metal bonding, and wire harnessing. HM350 stocked by APG has a thickness of .0035 inches with a backing thickness of .002 inches. It has a silicone adhesive with a breaking strength of 25 lb/in width, an electric strength of 7500 volts total, and a temperature range of -100°F to +500°F. Elongation 150%.

Size	Part Number
1/2" x 36 YD	12CHM350x1/2
3/4" x 36 YD	12CHM350x3/4

Note: Above CHR HM350 products are stocked by APG in the widths listed. Other widths are available by special order. Also, other HM series products with varying thicknesses are also available by special order.



**STYLE 12CT
STYLE 12CTH
STYLE 12CTV350**

**Temp-R-Tape®
T, TH, TV350**

Manufactured from Teflon® TFE and high pressure sensitive adhesive. The tapes differ in film gauge and in adhesive thickness. They are highly conformable, with excellent physical and electrical properties. Extremely low coefficient of friction, non-stick surface. Excellent release surface on packaging equipment. Also used in aircraft/aerospace, printing, textiles, plastics, and metal working industries. Temperature range: -100°F to +500°F. Elongation: T + TH - 2275%; TV350 - 250%.

Thickness Size	Breaking Strength w/Adhesive, inches	Electric Strength lb/in width	Volts Total	Part Number
1/2" x 36 YD	.006	25	10,000	12CT36x1/2
3/4" x 36 YD	.006	25	10,000	12CT36x3/4
1" x 36 YD	.006	25	10,000	12CT36x1
2" x 36 YD	.006	25	10,000	12CT36x2
4" x 36 YD	.006	25	10,000	12CT36x4
1/2" x 18 YD	.0125	60	18,000	12CTHx1/2
2 1/4" x 18 YD	.0125	60	18,000	12CTHx2-1/4
1/2" x 36 YD	.0035	15	7,800	12CTV350x1/2
1" x 36 YD	.0035	15	7,800	12CTV350x1
2" x 36 YD	.0035	15	7,800	12CTV350x2

Note: The above styles are stocked by APG in the sizes listed. Others are available by special order.

STYLE 12CK

Kapton® Temp-R-Tape®

Developed for the electronic assembly and electrical insulation markets. Primary applications include protecting printed circuit board connector fingers during wire soldering and hot air leveling and electrically insulating capacitors, coils, and other devices. Other applications include general insulation, lead holding and component masking. High conformability and resistance to solvents and high temperatures. Outstanding resistance to cut-through, impact and abrasion. K250 is the specific style stocked by APG. Other styles are available by special order that have different thicknesses or types of adhesive. K250 has a total thickness of .0025 inches and has a silicone adhesive. Tear strength: 25 lbs/in width. Dielectric strength: 6800 volts, total. Temperature range: -100°F to +500°F. K250 is recognized under the Components Program of Underwriters' Laboratories, Inc. Guide OAN, File E51201. Elongation 50%.

Size	Part Number
1/2" x 36 YD	12CK250x1/2
3/4" x 36 YD	12CK250x3/4
1" x 36 YD	12CK250x1

* Note: Other sizes available by special order.

**STYLE 12C500
STYLE 12C600
STYLE 12C700**

COHR Silicone Solid Rubber

Styles 500, 600, and 700 have durometers of 50, 60, and 70 respectively. General purpose molded silicone sheets. Silicone gives a high temperature stability and general inertness. Outdistances other elastomers in general service life, compression set resistance, electrical strength and non-stick properties. Good fluid and chemical resistance. May swell with contact to some solvents, but will return to original dimensions, usually without permanent deterioration, after the solvent has evaporated. At elevated temperatures, silicone will outgas for less than other elastomers. Odorless, tasteless, and non-toxic. Unaffected by sunlight, ozone and/or extremely moist or dry conditions. Will not support the growth of fungus. Styles 500, 600, and 700 have a tensile strength of 700 PSI. Maximum temperature range: -100°F to +500°F.

Size	Durometer	Elongation, %	Part Number
3/32" x 36" x 36"	50	350	12C500x093
3/16" x 36" x 36"	50	350	12C500x187
1/4" x 36" x 36"	50	350	12C500x250
3/8" x 36" x 36"	50	350	12C500x375
1/8" x 36" x 36"	60	200	12C600x125
3/16" x 36" x 36"	70	160	12C700x187
1/4" x 36" x 36"	70	160	12C700x250
1/2" x 36" x 36"	70	160	12C700x500

* Note: Other styles and thicknesses available by special order.

Refer to Product Index for Similar Products

STYLE 12C9750 COHR 9750 Silicone Solid Rubber

Size	Part Number
1/8" x 36"	12C9750x125

Style 9750 is a high value/low cost version of the general purpose series 500, 600, and 700. (For a general description of silicone, see Styles 500, 600, and 700). Style 9750 has a Durometer of 50 and a tensile strength of 800 PSI. Temperature range: -100°F to +500°F. Meets UL 1570, 1571, and 1572. Elongation 350%.

STYLE 12C3320 COHR 3320 Fiberglass Reinforced Silicone Rubber

Size	Part Number
1/16" x 36"	12C3320x062
3/32" x 36"	12C3320x093
1/8" x 36"	12C3320x125

Solid silicone rubber reinforced with fiberglass. Dimensionally stable, durable material for press pads, belting and gasketing. (See Styles 500, 600, and 700 for a general description of silicone.) Style 3320 is the reinforced style number stocked by APG. Other CHR styles are available by special order. Style 3320 has an actual rubber durometer of 60. Shore A durometers are as follows for various thicknesses: 1/16" = 74; 3/32" = 66; 1/8" = 65. Style 3320 was developed to meet AMS 3320. Consequently, it has lubricating oil resistance and excellent compression set resistance. Dielectric strength: 500 volts/mil (appr.). Elongation at break < 10%.

**STYLE 12CR10460
STYLE 12CR10470
STYLE 12CR10480 Silicone
Sponge Rubber**

Styles R10460, R10470, and R10480 are stocked by APG in the medium versions. Other styles are available by special order. These products are flexible, compressible COHRLastic silicone closed cell sponge designed for high performance gasketing, thermal shielding, vibration mounts and press pads. (See Style 500, 600, and 700 for a general description of silicone.) Style R10470 is a general purpose sponge and can be used in most applications. R10480 has extremely low compression set and maintains its resiliency even under extended compression. R10460 is flame retardant and also has extremely low compression set. It meets UL94 Flammability Classification 94HBR. All Styles have a dielectric strength of 145 volts/mil (appr.) and a temperature range of -100°F to +500°F. Outgassing (NASA testing) less than 1% weight loss.

Tensile Size	Elongation Strength	Compression at break, %	Set, %	Part Number
1/8" x 36" x 36"	75	125	5	12CR10460x125
3/16" x 36" x 36"	75	125	5	12CR10460x187
1/16" x 36" x 36"	90	200	25	12CR10470x062
1/8" x 36" x 36"	90	200	25	12CR10470x125
1/8" x 36" ROLL	90	200	25	12CR10470x125RF
3/16" x 36" x 36"	90	200	25	12CR10470x187
1/4" x 36" x 36"	90	200	25	12CR10470x250
3/4" x 36" x 36"	90	200	25	12CR10470x375
1/2" x 36" x 36"	90	200	25	12CR10470x500
1/16" x 36" x 36"	75	125	5	12CR10480x062
1/8" x 36" x 36"	75	125	5	12CR10480x125
3/16" x 36" x 36"	75	125	5	12CR10480x187
1/4" x 36" x 36"	75	125	5	12CR10480x250
3/8" x 36" x 36"	75	125	5	12CR10480x375
1/2" x 36" x 36"	75	125	5	12CR10480x500

Note: Sizes listed are stocked by APG. Others are available by special order. Specifications are for medium versions.

Refer to Product Index for Similar Products

Note: APG stocks all the products and indicated sizes in the CHR section of this catalog. Any CHR product is available by Special Order. Please inquire.



“America’s Most Responsive Warehouse”

Some of the Reasons Why



Huge inventories.



Same or next day shipment.



Sheet Materials - Elastomers

STYLE 0700 Red Rubber Smooth Finish 75 Durometer

Styrene Butadiene Rubber Sheet. Recommended for low applications such as washers and gaskets for the heating and plumbing trades. Low cost flange gasket material. Non-oil resistant compound that resists flow under compression. Offers moderate to good performance against low pressure. Good aging and abrasion resistance. Easily conforms to uneven flange surfaces. Durometer Hardness Shore A - 75±5. Tensile strength - 500 PSI. Temperature Range: -10°F to 200°F. Red color.

Size	Part Number
1/16" x 36"	0700062x36
1/8" x 36"	0700125x36
3/16" x 36"	0700187x36
1/4" x 36"	0700250x36
1/16" x 48"	0700062x48
1/8" x 48"	0700125x48
3/16" x 48"	0700187x48
1/4" x 48"	0700250x48

STYLE 0710 Red Rubber Cloth Finish

Styrene Butadiene Rubber Sheet. Excellent low cost flange gasket material. Non-oil resistant compound for air, hot and cold water, and exterior service. Durometer - 75 ±10/-5. Tensile strength - 400 PSI. Temperature range: -10°F to 200°F. Red color.

*1/32" x 36" and 1/8" x 72" - Smooth finish. 1/8" x 72" - 700 PSI tensile strength.

Size	Part Number
*1/32" x 36"	0710031x36
1/16" x 36"	0710062x36
1/8" x 36"	0710125x36
3/16" x 36"	0710187x36
1/4" x 36"	0710250x36
1/16" x 48"	0710062x48
1/8" x 48"	0710125x48
3/16" x 48"	0710187x48
1/4" x 48"	0710250x48
*1/8" x 72"	0710125x72

STYLE 0725S Neoprene 40 Durometer

Same as Style 0725 except with 40±5 Durometer. Temperature range: -20°F to +190°F.

Size	Part Number
1/16" x 36"	0725S062x36
1/8" x 36"	0725S125x36
3/16" x 36"	0725S187x36
1/4" x 36"	0725S250x36
1/16" x 48"	0725S062x48

STYLE 0725 Neoprene 60 Durometer

Neoprene blend provides moderate resistance to oil and ozone. For use in bumpers, pads, and sealing in general gasket and flange applications. Minimum tensile strength - 800 PSI. Durometer 60±5. Temperature range: -20°F to +170°F. Black color.

Size	Part Number
1/64" x 36"	0725015x36
1/32" x 36"	0725031x36
1/16" x 36"	0725062x36
3/32" x 36"	0725093x36
1/8" x 36"	0725125x36
3/16" x 36"	0725187x36
1/4" x 36"	0725250x36
5/16" x 36"	0725312x36
3/8" x 36"	0725375x36
1/2" x 36"	0725500x36
5/8" x 36"	0725625x36
3/4" x 36"	0725750x36
1" x 36"	07251x36
1" x 36" x 36"	07251x36x36
1/32" x 48"	0725031x48
1/16" x 48"	0725062x48
3/32" x 48"	0725093x48
1/8" x 48"	0725125x48
3/16" x 48"	0725187x48
1/4" x 48"	0725250x48
5/16" x 48"	0725312x48
3/8" x 48"	0725375x48
1/2" x 48"	0725500x48
5/8" x 48"	0725625x48
3/4" x 48"	0725750x48
1" x 48"	07251x48
1/8" x 72"	0725125x72

**Take advantage of our
Custom Fabrication Capabilities.
See pages 7 and 8 in this catalog.**



STYLE 0725H Neoprene 70 Durometer

Same as Style 0725 except with 70 Durometer.

Size	Part Number
2" x 36"	0725H1x36
1" x 41"	0725H1x41
1" x 48"	0725H1x48
2" x 32" x 32"	0725H2x32x32
2" x 38" x 38"	0725H2x38x38
2" x 45" x 45"	0725H2x45x45

STYLE 0725N Neoprene 70 Durometer - Cloth Finish

Same as Style 0725H except with cloth finish.

Size	Part Number
1/16" x 36"	0725N062x36

STYLE 0734 Cloth Finish Neoprene (70 Durometer)

Good resistance to ozone, sunlight, and outdoor weathering. Performs well in contact with many oils and chemicals. Cloth finish. Durometer 70±5. Tensile strength 1000 PSI. Elongation 200%. Temperature range -30°F to +200°F.

Size	Part Number
3/32" x 36"	0734093x36

STYLE 0734H Cloth Finish Neoprene (72 Durometer)

Good resistance to ozone, sunlight, and outdoor weathering. Performs well in contact with many oils and chemicals. Cloth finish. Durometer 72 ± 5. Tensile strength 1400 psi. Elongation 300%. Temperature range -40 to +220° F.

Size	Part Number
1/16" x 36"	0734H062x36
3/32" x 36"	0734H093x36
1/8" x 36"	0734H125x36

STYLE 0734W Cloth Finish White Neoprene (72 Durometer)

Good resistance to ozone, sunlight, and outdoor weathering. Performs well in contact with many oils and chemicals. Cloth finish. Durometer 72 ± 5. Tensile strength 1000 psi. Elongation 450%. Temperature range -40 to +220° F. Color: White. All ingredients listed as approved by FDA in 21 CFR 177.2600 for repeated food exposure.

Size	Part Number
1/16" x 36"	0734W062x36
3/32" x 36"	0734W093x36
1/8" x 36"	0734W125x36

STYLE 0726S Buna-N 50 Durometer

Good resistance to many oils and chemicals. Durometer 50±5. Tensile strength 800 PSI. Elongation 300%. Temperature range -20°F to 170°F.

Size	Part Number
1/16" x 36"	0726S062x36
1/8" x 36"	0726S125x36
3/16" x 36"	0726S187x36
1/4" x 36"	0726S250x36

STYLE 0726 Buna-N 60 Durometer

Buna-N (Nitrile) has very good resistance to many oils and chemicals. Durometer 60±5. Tensile strength 900 PSI. Elongation 250%. Temperature range -20°F to +170°F.

Size	Part Number
1/32" x 36"	0726031x36
1/16" x 36"	0726062x36
3/32" x 36"	0726093x36
1/8" x 36"	0726125x36
3/16" x 36"	0726187x36
1/4" x 36"	0726250x36
3/8" x 36"	0726375x36
1/2" x 36"	0726500x36
5/8" x 36"	0726625x36
3/4" x 36"	0726750x36
1/16" x 48"	0726062x48
1/8" x 48"	0726125x48
3/16" x 48"	0726187x48
1/4" x 48"	0726250x48
3/8" x 48"	0726375x48
1/2" x 48"	0726500x48
5/8" x 48"	0726625x48
3/4" x 48"	0726750x48



STYLE 0726P High Grade Buna-N 60 Durometer

Size	Part Number
1/8" x 36"	0726P125x36

A high grade Buna-N compound designed for more demanding applications usually involving petroleum based oils and fuels. Polymer content 100% butadiene acrylonitrile. Tensile strength 1500 PSI. Elongation 300%. Show A Hardness 60±5. Temperature range -30°F to 250°F.

STYLE 0735 Cloth Finish Buna-N (70 Durometer)

Size	Part Number
3/32" x 36"	0735093x36

A cloth finish compound with 70% Buna and 30% SBR. Durometer 70±5. Tensile strength 1200 PSI. Elongation 200%. Temperature range -20°F to 200°F.

STYLE 0726T Buna-N 70 Durometer for Transformer Gaskets and Strip

Size	Part Number
1/16" x 36"	0726T062x36
1/8" x 36"	0726T125x36
3/16" x 36"	0726T187x36
1/4" x 36"	0726T250x36

Especially selected for the fabrication of gaskets and strip for transformers. High resistance to transformer oils. Durometer 70±5. Tensile strength 1500 PSI. Elongation 250%. Temperature range -30°F to 250°F.

STYLE 0726H Buna-N 90 Durometer

Size	Part Number
1/16" x 36"	0726H062x36
3/32" x 36"	0726H093x36
1/8" x 36"	0726H125x36

Good resistance to many oils and chemicals. Durometer 90±5. Tensile strength 1500 PSI. Elongation 100%. Temperature range -30°F to 250°F.

STYLE 0726W Buna-N White 50-65 Durometer

Size	Part Number
1/32" x 36"	0726W031x36
1/16" x 36"	0726W062x36
1/8" x 36"	0726W125x36
3/16" x 36"	0726W187x36
1/4" x 36"	0726W250x36
3/8" x 36"	0726W375x36

Manufactured from FDA approved ingredients. Good resistance to oily and greasy food products. Good resistance to abrasion. Non-toxic and non-marking. Durometer 55 +10/-5. Tensile strength 1000 PSI. Elongation 400%. Temperature range -20°F to 200°F.

STYLE 0716 Pure Gum Rubber Tan Floating Stock

Size	Part Number
1/32" x 36"	0716031x36
1/16" x 36"	0716062x36
1/8" x 36"	0716125x36
3/16" x 36"	0716187x36
1/4" x 36"	0716250x36
3/8" x 36"	0716375x36
7/16" x 36"	0716437x36
1/2" x 36"	0716500x36
5/8" x 36"	0716625x36
3/4" x 36"	0716750x36
1" x 36"	07161x36
1/16" x 48"	0716062x48
1/8" x 48"	0716125x48
3/16" x 48"	0716187x48
1/4" x 48"	0716250x48
3/8" x 48"	0716375x48
1/2" x 48"	0716500x48
5/8" x 48"	0716625x48
3/4" x 48"	0716750x48
1" x 48"	07161x48

Full-floating, natural rubber. For installation requiring high tensile and elongation characteristics along with superior abrasion resistance. Also for applications requiring a soft rubber seal. Conforms to irregular flanges with bolt heads. Resists most organic salts, acids, alkalis, and ammonia. Non-marking. Tensile strength 3000 PSI. Durometer 40±5. Elongation 600%. Temperature range -20°F to +140°F. Smooth finish. Tan color.



STYLE 0722 Fluoroelastomer, Premium Grade Plate Finish 75 Durometer

Used where chemical resistance, low gas permeability and continuous service at extreme temperatures are required. Widely used in the aerospace and automotive industries. Durometer 75±5 Tensile strength 800 PSI. Elongation 225%. Temperature range -20°F to 400°F; intermittent to 450°F.

Size	Part Number
1/32" x 36"	0722031x36
1/16" x 36"	0722062x36
1/8" x 36"	0722125x36
3/16" x 36"	0722187x36
1/4" x 36"	0722250x36
1/16" x 48"	0722062x48
1/8" x 48"	0722125x48

STYLE 0723S EPR 40 Durometer

Same as Style 0723 with 40 Durometer.

Size	Part Number
1/8" x 36"	0723S125x36

STYLE 0723 EPR 60 Durometer

Excellent general purpose rubber. Excellent resistance to heat, cold ozone, and ultraviolet light. This makes it an excellent material for outdoor applications. Also has excellent chemical resistance. Excellent electrical and dynamic properties. Not oil resistant. Tensile strength 800 PSI. Durometer 60±5. Temperature range -20°F to 220°F.

Size	Part Number
1/16" x 36"	0723062x36
3/32" x 36"	0723093x36
1/8" x 36"	0723125x36
3/16" x 36"	0723187x36
1/4" x 36"	0723250x36
3/32" x 48"	0723093x48
1/8" x 48"	0723125x48

STYLE 0723P EPR Peroxide Cured 60 Durometer

Similar to Style 0723 except peroxide cured. Tensile strength 1800 PSI. Elongation 400%.

Size	Part Number
1/16" x 48"	0723P062x48
1/8" x 48"	0723P125x48

STYLE 0728 Butyl 60 Durometer

Good resistance to gas permeation. Non-oil resistant. Many applications. Commonly used in inner tubes and tire inner liners. Resistance to flexing and abrasion is very good. Durometer 60±5. Tensile strength 1100 PSI. Elongation 400%. Temperature range -40°F to 180°F.

Size	Part Number
1/16" x 36"	0728062x36
1/8" x 36"	0728125x36
1/4" x 36"	0728250x36

STYLE 0729S Silicone Rubber 40 Durometer

Same as Style 0729 except with 40 Durometer. Tensile strength 700 psi. Elongation 240%.

Size	Part Number
3/32" x 36"	0729S093X36

STYLE 0729 Silicone Rubber 50 Durometer

Meets MIL-R-5847/ZZR-765. Excellent heat resistance, low temperature flexibility, resistance to compression set. Resistance to ozone, aging, sunlight and many common fuels, oils and chemicals. Durometer 50. Temperature range -80°F to +425°F. Tensile strength 700 PSI. Elongation 250%. Red color.

Size	Part Number
1/32" x 36"	0729031x36
1/16" x 36"	0729062x36
1/8" x 36"	0729125x36
3/16" x 36"	0729187x36
1/4" x 36"	0729250x36



STYLE 0729H Silicone Rubber 70 Durometer

Same as Style 0729 except with 70 Durometer. Tensile strength 650 PSI. Elongation 225%.

Size	Part Number
1/32" x 36"	0729H031x36
1/16" x 36"	0729H062x36
3/32" x 36"	0729H093x36
1/8" x 36"	0729H125x36
3/16" x 36"	0729H187x36
1/4" x 36"	0729H250x36

STYLE 0729W Silicone Rubber (White) 60 Durometer

White silicone rubber. Durometer 60. Elongation 240-400%. Tensile strength 650-780 PSI. Temperature range -80°F to +425°F.

Size	Part Number
1/8" x 36"	0729W125X36

STYLE 0730 Cloth Inserted Black Rubber 60 Durometer

SBR with 6 oz. cotton cloth inserted to reduce movement and creep. Durometer 60±5 (SBR material only). Tensile strength 1200 PSI. Elongation 400%. Temperature range 0°F to 212°F. Nylon finish.

Size	Part Number
1/16" x 36"	0730062x36
3/32" x 36"	0730093x36
1/8" x 36"	0730125x36
3/16" x 36"	0730187x36
1/4" x 36"	0730250x36
1/16" x 48"	0730062x48
3/32" x 48"	0730093x48
1/8" x 48"	0730125x48
3/16" x 48"	0730187x48
1/4" x 48"	0730250x48

STYLE 0741 Neoprene Duck Inserted Diaphragm

Oil-resistant neoprene diaphragm material designed to transmit pulsations between gases, air, and fluids. Reinforced with cotton duck to provide structural strength. Durometer 70±5. Tensile strength 1500 PSI. Elongation 300%. Temperature range -40°F to 220°F. Smooth finish.

Size	Part Number
1/16" x 48"	0741062x48
1/8" x 48"	0741125x48
3/16" x 48"	0741187x48
1/4" x 48"	0741250x48

STYLE 0742 Neoprene Nylon Inserted Diaphragm

Oil-resistant neoprene diaphragm material reinforced with nylon for increased structural strength. Durometer 70±5. Tensile strength 1500 PSI. Elongation 300%. Temperature range -40°F to 220°F. Smooth finish.

Size	Part Number
1/16" x 48"	0742062x48
1/8" x 48"	0742125x48

STYLE 0743 Buna-N Nylon Inserted Diaphragm

Nitrile polymer with nylon insertion. Temperature range -20°F to 200°F.

Size	Part Number
.017" x 54"	0743017x54
.025" x 58"	0743025x58
.050" x 57"	0743050x57
1/16" x 48"	0743062x48
1/8" x 48"	0743125x48

Refer to Product Index for Similar Products



STYLE 0759CCE Closed Cell Nitrile PVC Sponge

Black, closed cell sheet material. Skin on two sides. Compatible with most film adhesives. Especially suited to the manufacture of stripping and die cut parts. Nitrile/PVC composition. Compression deflection 5-9 PSI. Density 7-12 lbs/cubic foot. Water absorption 5% maximum. Temperature range -20°F to 160°F (continuous) (to 220°F intermittent). Compression set 25% maximum. Shrinkage 1/4" thick and under 4% maximum, 5/16" and over 3% maximum. Tensile strength 70 PSI. Elongation 100%.

Size	Part Number
1/8" x 48" x 250'	0759CCE125x48
3/16" x 48" x 165'	0759CCE187x48
1/4" x 48" x 125'	0759CCE250x48
3/8" x 48" x 85'	0759CCE375x48
1/2" x 48" x 60'	0759CCE500x48
5/8" x 48" x 50'	0759CCE625x48
3/4" x 48" x 40'	0759CCE750x48
1" x 48" x 30'	0759CCE1x48

STYLE 0760 Rubber Sponge Medium Density

Natural rubber open cell sponge. Compression deflection at 25%: 5-10 PSI. Compression set 15% maximum. Density 26 lbs/cubic foot. Temperature range -40°F to 160°F. Black color.

Size	Part Number
1/8" x 36"	0760125x36
3/16" x 36"	0760187x36
1/4" x 36"	0760250x36
3/8" x 36"	0760375x36
1/2" x 36"	0760500x36
5/8" x 36"	0760625x36
3/4" x 36"	0760750x36
1" x 36"	07601x36

STYLE 0760T Rubber Sponge Medium Density (Tan)

Natural rubber open cell sponge. Compression deflection at 25%: 5-10 PSI. Compression set 15% maximum. Density 26 lbs/cubic foot. Temperature range -40°F to 160°F. Tan color.

Size	Part Number
5/16" X 36"	0760T312X36

STYLE 0731M Medium Density Silicone Sponge

Silicone sponge rubber with a density of .020 lbs/cu. in. Compression deflection 6-14 psi. Compression set 25%. Tensile strength 90 psi. Elongation 200%. Water absorption 5%. Temperature range -67°F to +500°F. Red color.

Size	Part Number
1/16" X 36" Roll	0731M062X36
1/8" X 36" Roll	0731M125X36
3/16" X 36" Roll	0731M187X36
1/4" X 36" Roll	0731M250X36
3/8" X 36" Roll	0731M375X36
1/2" X 36" X 36" Sheet	0731M500X36X36





Other Sheet Materials and Tapes

STYLE 0D9000 Durlon® 9000 Filled PTFE

Pure PTFE resins with homogeneously blended inorganic fillers. Designed for use in process piping and equipment in chemical, pulp and paper, food and beverage, and other general industrial applications. Suitable for use in steel flanges and will not exhibit the cold flow problems associated with virgin PTFE or the hardness problems of some filled PTFE products. Temperature range: -350°F to 500°F. Maximum pressure: 1500 PSI. Certified for oxygen service at oxygen pressures up to 585 PSI and temperatures up to 392°F, and for service in liquid oxygen by the Federal Institute for Materials Testing and Research, Berlin, Germany. Tensile strength - ASTM F152: 2000 PSI. Compressibility - ASTM F36: 8 to 16%. Recovery - ASTM F36: 40%. Sealability - ASTM F37: 0.02 ml/hr. Creep relaxation - ASTM F38: 30%. Flexibility - ASTM F147: Sx. Color: Blue (9000 N is unpigmented white, unbranded. Not an APG stock item. Special order.)

Size	Part Number
*1/32" x 60" x 60"	
1/16" x 60" x 60"	0D9000062x60x60
1/8" x 60" x 60"	0D9000125x60x60

* Not an APG stock item. Special order.

STYLE 0800 TFE

Grade #1 reprocessed fluoropolymer. Tensile strength, CD - 1500 to 2400 PSI. Tensile elongation 75 - 200%. Dielectric strength (60 mil thickness) 450 volt/mil.

Size	Part Number
.010" x 24" wide	0800010x24
1/64" x 48" x 48"	0800015x48x48
1/32" x 48" x 48"	0800031x48x48
1/16" x 48" x 48"	0800062x48x48
1/8" x 48" x 48"	0800125x48x48
3/16" x 48" x 48"	0800187x48x48
1/4" x 48" x 48"	0800250x48x48

STYLE 0801 25% Glass Filled TFE

75% TFE and 25% glass fiber. Since glass has the least effect on chemical and electrical properties and adds greatly to mechanical properties of unfilled TFE, glass fiber compounds have the best balance of chemical, electrical, and mechanical properties of any of the filled TFE compounds. Glass-filled-TFE seals offer the advantages of the unfilled resin plus longer wear, higher thermal conductivity, increased dimensional stability, and lower cold flow. Used in applications such as bearings, gaskets, V-Rings, O-Rings, back-up rings, hydraulic ring seals, non-lubricated compressor rings, valve seats, valve liners, swivel liners, thrust washers, lip seals, standoff and feed-through insulators, and other applications in the chemical, electrical, and mechanical fields. Tensile strength CD - 2700 PSI. Elongation CD - 250%. Initial hardness, Shore D - 63. Compressive strength CD (0.2% offset) 1240 PSI.

Size	Part Number
1/32" x 48" x 48"	0801031x48x48
1/16" x 48" x 48"	0801062x48x48
1/8" x 48" x 48"	0801125x48x48

Refer to Product Index for Similar Products

**STYLE 0825****Grafoil® GH™E**

Grafoil® flexible graphite laminate with tang 316/316L stainless steel insert (0.004" thick) made from material typically 97.0% graphite. Leachable chloride typically less than 50 PPM. No binders or resins. Mechanical bond. Non-fibrous. Non-asbestos. Sulphur content < 500 ppm. Compressibility: 30%. Recovery: 30%. Creep relaxation: < 5%. Tensile strength: 3800 PSI. Temperature range (oxidizing atmosphere): -400°F to 750°F. (Properties based on 1/16" thickness.)

Size	Part Number
1/16" x 39" x 39"	0825062x39x39
1/8" x 39" x 39"	0825125x39x39

STYLE 0826**Grafoil® GH™L**

Grafoil® flexible graphite laminate made from material typically 97.0% graphite. Leachable chloride typically less than 50 PPM. No binders or resins. Adhesive bond. Sulphur content < 500 ppm. Compressibility: 40%. Recovery: 20%. Creep relaxation: < 5%. Sealability: < 0.12 fluid ounces/hr. Tensile strength: 650 PSI. Temperature range (oxidizing atmosphere): -400°F to 750°F.

Size	Part Number
1/16" x 39" x 39"	0826062x39x39
1/8" x 39" x 39"	0826125x39x39

STYLE 0828**Grafoil® GH™R**

Grafoil® flexible graphite laminate with flat 316/316L stainless steel insert (0.002" thick) made from material typically 97.0% graphite. Leachable chlorides typically less than 50 ppm. No binders or resins. Adhesive bond. Non-fibrous and non-asbestos. Sulphur content < 500 ppm. Compressibility: 40%. Recovery: 20%. Creep relaxation: < 5%. Tensile strength: 3800 PSI. Temperature range (oxidizing atmosphere): -400°F to 750°F.

Size	Part Number
1/32" x 39" x 39"	0828031x39x39
1/16" x 39" x 39"	0828062x39x39
1/16" x 60" x 60"	0828062x60x60
1/8" x 39" x 39"	0828125x39x39

STYLE 0832**316 S.S. Tang Flexible Graphite**

Flexible graphite laminate with tang 316 stainless steel insert (0.005" thick) made from material typically 98% graphite. Leachable chloride typically less than 50 ppm. Sulfur content: < 500 ppm. Compressibility: 35%. Recovery: 18%. Creep relaxation: 10%. Density: 62.4 lbs/ft. Tensile strength: 5000 PSI. Temperature range (oxidizing atmosphere): -400° F to 750° F.

Size	Part Number
1/16" x 39" x 39"	0832062x39x39
1/8" x 39" x 39"	0832125x39x39

STYLE 0833**Flexible Graphite**

Flexible graphite made from material typically 98% graphite. Leachable chloride typically less than 50 ppm. Sulfur content: < 500 ppm. Compressibility: 45%. Recovery: 20%. Creep relaxation: 5%. Density: 62.4 lbs/ft. Tensile strength: 700 PSI. Temperature range (oxidizing atmosphere): -400° F to 750° F.

Size	Part Number
1/16" x 39" x 39"	0833062x39x39
1/8" x 39" x 39"	0833125x39x39

STYLE 0834**316 S.S. Foil Flexible Graphite**

Flexible graphite sheet reinforced with a 316 stainless steel foil (0.002" thick) made from material typically 98% graphite. Leachable chloride typically less than 50 ppm. Sulfur content: < 500 ppm. Compressibility: 35%. Recovery: 18%. Creep relaxation: 12%. Density: 62.4 lbs/ft. Tensile strength: 5000 PSI. Temperature range (oxidizing atmosphere): -400° F to 750° F.

Size	Part Number
1/32" x 39" x 39"	0834031x39x39
1/16" x 39" x 39"	0834062x39x39
1/8" x 39" x 39"	0834125x39x39

STYLE 0718 Koroseal® 75 Durometer

Size	Part Number
1/16" x 36"	0718062x36
1/8" x 36"	0718125x36

Specially formulated PVC (polyvinylchloride) which displays excellent water resistance and is unaffected by most acids, alkalis and other corrosive chemicals. Can handle certain concentrations of oxidizing agents such as potassium permanganate, chromic and nitric acid, hydrogen peroxide and sodium perborate. Excellent chemical resistance to certain petroleum based lubricating oils. Not to be used in applications above 140°F. Material properties relating to dimensional stability for thermoplastics will typically differ from comparable thermoset rubber offerings. Tensile strength -1800 PSI. Elongation -300%. Hardness Shore A -75±5.

STYLE 0721 Hypalon

Size	Part Number
1/16" x 36"	0721062x36
1/8" x 36"	0721125x36
1/4" x 36"	0721250x36

Highly resistant to most acids and other corrosives. Commonly used as a covering in soil burial because it is unaffected by soil chemicals and moisture. Excellent ozone and U.V. resistance. Tensile strength 1500 PSI. Elongation 350%. Temperature range -20°F to 200°F.

STYLE 0732 Corrugated Vinyl Matting

Size	Part Number
1/8" x 36"	0732125x36

Durable vinyl runner featuring angular pointed corrugations running lengthwise. Textured impression back. Provides floor protection and safety. Exceptional wear. Good resistance to many acids and chemicals. Easy to clean. Improves traction. Tear resistant. Stain and abrasion resistant.

STYLE 0795 Grey Felt Medium Density

Size	Part Number
1/8" x 72"	0795125x72
3/16" x 72"	0795187x72
1/4" x 72"	0795250x72
3/8" x 72"	0795375x72
1/2" x 72"	0795500x72
5/8" x 72"	0795625x72
3/4" x 72"	0795750x72
1" x 72"	07951x72

75% wool recommended for sound deadening, chassis strips, spacers, dust shields, pedal pads, dash liners, and for mechanical purposes where abrasion and wear are not important factors. SAE F-13.

STYLE 0796 Grey Felt Firm

Size	Part Number
1/8" x 60"	0796125x60
3/16" x 60"	0796187x60
1/4" x 60"	0796250x60
1/2" x 60"	0796500x60
3/4" x 60"	0796750x60

85% wool recommended for vibration mountings. Also for oil retention in installations where felt is not compressed, washers bushings, and door bumpers where wear and abrasion are not important factors. SAE F-3.

STYLE 0797 White Felt Firm

Size	Part Number
1/8" x 60"	0797125x60
1/4" x 60"	0797250x60
3/8" x 60"	0797375x60
1/2" x 60"	0797500x60

95% wool suitable for oil retention in installations where felt is not compressed, for feeding low viscosity or light oil, and where unusual strength and hardness are required. Washers, bushings, wicks, door bumpers, polishing blocks, and parts where wear and resistance to abrasion are required are typical uses. SAE F-1.

STYLE 0747 Orange or Black Leather

Meets MIL Spec W5521A.

Size	Part Number
1/16" x 12" x 24"	0747062
3/32" x 12" x 24"	0747093
1/8" x 12" x 24"	0747125

STYLE 0748 Tan Leather Hides

Tanned cowhide.

Size	Part Number
3/16" THK, 10-11 OZ.	0748187
1/4" THK, 11-12 OZ.	0748250

STYLE 0761 Double Adhesive with Release Liner

High tack, low dead load acrylic adhesive coated on the exposed side of a 1/2 mil polyester film. On the user side is a rubber based adhesive which exhibits excellent initial tack, high peel strength and moderate shear. Works well in conjunction with some PVC and neoprene closed cell rubber products. Also with cork and rubber composites as well as many urethane foams. The polyester carrier offers excellent dimensional stability for die cutting. Thickness: carrier - 0.5 mils, adhesive exposed side - 1.5 mils, adhesive liner side - 1.3 mils, 74# release liner - 5.5 mils.

Size	Part Number
44" x 250 YD	076144
54" x 250 YD	076154

STYLE 0764 Fiberglass Cloth

Excellent temperature and strength properties, along with rot and mildew resistance, make fiberglass fabrics valuable over a broad range of marine and industrial applications. Will not rot, mildew or deteriorate. Resist most acids with the exception of hydrofluoric acid and hot phosphoric acid. Low coefficient of thermal expansion and relatively high thermal conductivity. Will dissipate heat more rapidly than asbestos or organic fibers. Will not burn; basically unaffected by high baking and curing temperatures. Can often replace more costly insulation. Insulation service temperature to 1200°F. Major use is welding protection.

Weight and Dimensions		Part Number
13 OZ.	.014" x 60" x 150'	0764GL1400B609383
17.7 OZ.	.030" x 60" x 150'	0764192660
33 OZ.	.060" x 60" x 150'	07643500609752

STYLE 0762 Non-asbestos, Wire-inserted, Fiberglass Tacky Cloth

Non-asbestos blended cloth consisting of fiberglass and proprietary products. Provides a superior bond between the fiberglass composite and the rubber compound. Brass wire inserted to provide strength and conformability. Ideal for manhole, handhole, and tadpole gaskets. Service rating +400°F. Pressure rating 180 PSI.

Size	Part Number
1/16" x 40"	0762062x40

STYLE 0763 Dry Woven Fiberglass Cloth

Woven with texturized roving yarns. Non-flammable, high heat resistance. may be used at surface temperatures ranging from 120°F to 1000°F. Retains 50% of tensile strength at 700°F, and as much as 25% at 1000°F. Will not stretch or shrink. No more than 3% elongation under maximum stress. Retains stability even at high temperatures. Highly resistant to most chemicals except hydrofluoric and hot phosphoric acid and wet hydrogen chloride. Will not rot or mildew.

Size	Part Number
1/16" x 40" x 50 YD	0763062x40
1/8" x 40" x 50 YD	0763125x40
.040" x 60" x 50 YD	0763040x60



STYLE 911F

Non-asbestos Tadpole Tape with Non-Asbestos Rope

Non-asbestos tadpole tape utilizing woven fiberglass cloth with brass wire inserted in both directions as the external portion of the product. The core portion in the bulb is a twisted fiberglass rope. The external portion of the product is rated to 400°F.



Typical Dimensions (inches)	
3/8" x 1"	3/8" x 1 1/4"
3/8" x 1 3/8"	
3/8" x 1 1/2"	3/8" x 2"
3/8" x 2 1/2"	
1/2" x 1 1/4"	1/2" x 1 1/2"
1/2" x 1 3/4"	
1/2" x 2"	1/2" x 2 1/8"
1/2" x 2 1/2"	
5/8" x 1"	5/8" x 1 3/8"
5/8" x 1 1/2"	
5/8" x 2"	5/8" x 2 1/2"
5/8" x 2 1/2"	3/4" x 1 1/4"
3/4" x 1 1/2"	3/4" x 2"
3/4" x 2 1/4"	
3/4" x 2 1/2"	

STYLE 0912

Fiberglass Tape

Fiberglass tape (plain) withstands temperatures up to 1000°F. Applications include wrapping steam tracer lines, hose, piping, tadpole tapes, gasketing, and curtains for high temperature ovens.

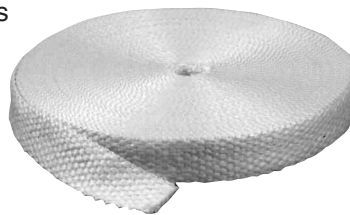

Thickness	Width	Length	Part Number
1/16"	1"	100'	0912062x1
1/16"	1 1/2"	100'	0912062x-1/2
1/16"	2"	100'	0912062x2
1/16"	3"	100'	0912062x3
1/16"	4"	100'	0912062x4
1/8"	1"	100'	0912125x1
1/8"	1 1/2"	100'	0912125x1-1/2
1/8"	2"	100'	0912125x2
1/8"	3"	100'	0912125x3
1/8"	4"	100'	0912125x4

STYLE 0914

Drop Warp Fiberglass Tape

Fiberglass tape (drop warp) withstands temperatures up to 1000°F. Applications include wrapping, steam tracer lines, hose, piping, tadpole tapes, gasketing, and curtains for high temperature ovens.

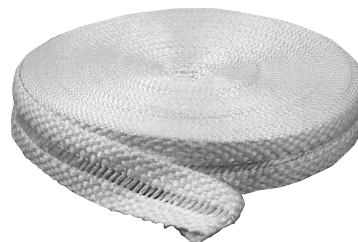

Thickness	Width	Length	Part Number
1/16"	1 1/2"	100'	0914062x1-1/2
1/16"	2"	100'	0914062x2
1/16"	3"	100'	0914062x3
1/8"	1"	100'	0914125x1
1/8"	1 1/2"	100'	0914125x1-1/2
1/8"	2"	100'	0914125x2
1/8"	3"	100'	0914125x3
1/8"	4"	100'	0914125x4

STYLE 907FC

Folded Non-asbestos Tape

Folded non-asbestos tape. Woven fiberglass tacky cloth with brass wire inserted in both directions. Rated to 400°F. Standard thicknesses: 1/8", 3/16", and 1/4". Call for other possible thicknesses and widths.

Typical Dimensions (inches)	
3/4"	1"
1 1/4"	
1 1/2"	1 3/4"
2"	

**STYLE 909F****Lead Core Packing**

Woven fiberglass tacky cloth wire brass wire inserted in both directions surrounding a lead core. Rated to 400°F.

**Dimensions**

1/2" DIA. x 25 FT.

STYLE 0775**Red Vulcanized Fibre**

Chemically pure, cellulose material that contains no resins or bonding agents. Extremely high internal bond strength. Will not delaminate or separate, even in water. Resistant to oils, gasolines, and most solvents. Red color. Tensile strength: MD-18,000 PSI, CD-9000 PSI. Compressive strength 35,000 PSI. Hardness, Rockwell, R Scale 80. Dielectric strength, short time, volts/mil: 1/64" - 230, 1/16" - 200, 1/8" - 195. Heat resistance, continuous (UL File #E48013) 110°C. Mechanical, 115°C. Electrical. Water absorption, 24 hours - 66%.

Size	Part Number
1/64" x 50" x 80"	0775015x50x80
1/32" x 51.5" x 84.5"	0775031x50x80
1/16" x 48.5" x 84.5"	0775062x50x80
1/8" x 48" x 78"	0775125x48x78

STYLE 0790**Fine Grain Cork**

For gaskets with low to medium torque loads for automotive fluid seals, gear boxes, oil seals, valve covers, etc. Density 17 lbs/cubic foot. Tensile strength 100 PSI. Compressibility @ 100 PSI: 25-40. MIL-HHC-576 B Ty I & II, CL2. F-104 Call Out F-2190000.

Size	Part Number
1/32" x 28" x 50"	0790031x28x50
1/16" x 28" x 50"	0790062x28x50
3/32" x 28" x 50"	0790093x28x50
1/8" x 28" x 50"	0790125x28x50
3/16" x 28" x 50"	0790187x28x50
1/4" x 28" x 50"	0790250x28x50
3/8" x 28" x 50"	0790375x28x50
1/2" x 28" x 50"	0790500x28x50

STYLE 0777**Fibrecork Sheet**

Composition cork and fibre glue-glycerine impregnated gasket material. Special base fibre containing 40% granulated cork particles by volume. Saturated with a glue-glycerine-formaldehyde impregnant which makes the sheet impervious to oil, water and gasoline. The incorporation of the cork with the fibre makes a soft compressible material adaptable for gasket application with low internal pressures. Compressibility 40% to 55%. Tensile strength 1000 PSI. Flexibility: capable of withstanding bending around a rod with a diameter of twice the thickness of the material under test, without cracking, breaking or excessive marring of the surfaces. Temperature limit 250°F.

Size	Part Number
1/64" x 36"	0777015x36
1/32" x 36"	0777031x36
1/16" x 36"	0777062x36
1/8" x 36"	0777125x36

STYLE 0780**Plant Fibre Sheet**

Excellent grade of vegetable fibre sheet packing, efficiently saturated with a glue-glycerine impregnant rendered insoluble by means of a tanning agent (formaldehyde) to give a strong, flexible, all-proof packing with properties retained during proper storage and in use. Compressibility 25% to 40%. Tensile strength 2000 PSI. Flexibility: capable of withstanding bending around a rod with a diameter of twice the thickness of the material under test, without cracking, breaking or excessive marring of the surfaces. Temperature limit 250°F.

Size	Part Number
.006" x 36" x 200 YD	0780006x36
.010" x 36" x 200 YD	0780010x36
1/64" x 36" x 200 YD	0780015x36
1/32" x 36" x 100 YD	0780031x36
1/16" x 36" x 50 YD	0780062x36
3/32" x 36" x 25 YD	0780093x36
1/8" x 36" x 25 YD	0780125x36

Refer to Product Index for Similar Products

**STYLE 0778 Fish Paper**

Size	Part Number
.010" x 25" x 40"	0778010x25x40

Intended for electrical applications involving high dielectric strength, plus good forming and bending qualities. Applications include all types of armature slot insulations, arc shields, coil insulations, insulation washers, and formed specialties.

STYLE 0781 White Bluetex Vellum

Size	Part Number
.003" x 42" x 50 YD	0781003x42

100% rag, 17 pound white vellum stock.

STYLE 0NOMEX Nomex® Aramid Paper

Size	Part Number
10 mils X 36"	0NOMEX010X36

Designed for applications requiring a strong, yet flexible and conformable sheet. Designed for use as slot insulation in hand-wound motors and for linear wrapping of wire, but is also used in other applications where its specific characteristics are desirable (such as folded or punched parts). Dielectric strength (AC Rapid Rise - ASTM D-149 - 750 v/mil) (Full wave impulse - ASTM D-3426 - 1300 V/mil). Dielectric strength numbers are typical data using 2 inch flat electrodes, and should not be used for design purposes. Tensile strength (ASTM D-828) machine direction 140 lb/in; cross direction 70 lb/in. Elongation (ASTM D-828) machine direction 14%; cross direction 17%. Initial tear resistance (ASTM D-1004) machine direction 16.0 lb; cross direction 7.7 lb. Nominal thickness - 10 mils. Width - 36".

STYLE 0952 Mica Sheet

Thickness	Dimensions	Part Number
.004" - .006"	7" x 7"	0952004x7x7

100% Natural mica. High heat resistance, transparency, optical clarity, flexibility, flatness, and non-breakability. Resists shocks, strains, and vibrations. Resists chemical abrasion. Low coefficient of thermal expansion. Withstands temperatures up to 600°C (1112°F).

STYLE 0954 Daikin PCTFE Sheet

Thickness	Dimensions	Part Number
1/16"	14" x 14"	0954062x14x14

Homopolymer of chlorotrifluoroethylene. Unique thermoplastic that offers high optical transparency, chemical resistance, near zero moisture absorption and excellent electrical properties. Non-flammable. Temperature range -400°F to +400°F. Wide variety of applications, including valves, valve seats, seals, packaging, gaskets, bearings, and liquid gauge shields.

Need assistance?
Ask our experienced sales staff.

We are here to help!



O-Ring Cord Stock and Extrusions



Style 0281

Aflas® O-Ring Cord
75 Durometer

Cross Section		Part Number
Nominal (Inches)	Actual (Inches)	
3/32"	.103 - .006/+0.012	0281103
1/8"	.139 - .006/+0.014	0281139
3/16"	.210 - .006/+0.014	0281210
1/4"	.250 - .010/+0.022	0281250
	.275 - .010/+0.022	0281275
5/16"	.312 - .010/+0.022	0281312
3/8"	.375 - .010/+0.022	0281375

Style 0282

EPDM (EPR) O-Ring Cord
70 Durometer

Cross Section		Part Number
Nominal (Inches)	Actual (Inches)	
1/16"	.070 ± .005	0282070
3/32"	.093 ± .005	0282093
	.103 ± .005	0282103
1/8"	.125 ± .005	0282125
	.139 ± .007	0282139
3/16"	.187 ± .007	0282187
	.210 ± .007	0282210
1/4"	.250 ± .008	0282250
	.275 ± .008	0282275
5/16"	.312 ± .010	0282312
3/8"	.375 ± .010	0282375
7/16"	.437 ± .010	0282437
1/2"	.500 ± .012	0282500
5/8"	.625 ± .012	0282625
3/4"	.750 ± .016	0282750
1"	1.000 ± .020	02821

Style 0283

Fluoroelastomer O-Ring
Cord 75 Durometer

Cross Section		Part Number
Nominal (Inches)	Actual (Inches)	
1/16"	.070 ± .010	0283070
3/32"	.093 ± .010	0283093
	.103 ± .013	0283103
1/8"	.125 ± .013	0283125
	.139 ± .016	0283139
3/16"	.187 ± .016	0283187
	.210 ± .016	0283210
1/4"	.250 ± .016	0283250
	.275 ± .020	0283275
5/16"	.312 ± .020	0283312
3/8"	.375 ± .020	0283375
7/16"	.437 ± .025	0283437
1/2"	.500 ± .025	0283500
5/8"	.625 ± .025	0283625
3/4"	.750 ± .032	0283750
1"	1.000 ± .032	02831

Style 0283H

Fluoroelastomer O-Ring Cord
90 Durometer

Cross Section		Part Number
Nominal (Inches)	Actual (Inches)	
1/16"	.070 ± .004	0283H070
3/32"	.103 ± .006	0283H103
	.125 ± .013	0283H125
1/8"	.139 ± .016	0283H139
	.187 ± .016	0283H187
3/16"	.210 ± .016	0283H210
	.250 ± .016	0283H250
1/4"	.275 ± .020	0283H275
	.312 ± .020	0283H312
5/16"	.375 ± .020	0283H375



Style 0283VB

**Brown Fluoroelastomer
O-Ring Cord
75 Durometer**

Cross Section		Part Number
Nominal (Inches)	Actual (Inches)	
1/8"	.125 ± .013	0283VB125
	.139 ± .016	0283VB139
3/16"	.187 ± .016	0283VB187
	.210 ± .016	0283VB210
1/4"	.250 ± .016	0283VB250
	.275 ± .020	0283VB275
5/16"	.312 ± .020	0283VB312
3/8"	.375 ± .020	0283VB375
7/16"	.437 ± .025	0283VB437
1/2"	.500 ± .025	0283VB500

Style 0284H

**Buna-N O-Ring Cord
90 Durometer**

Cross Section		Part Number
Nominal (Inches)	Actual (Inches)	
3/32"	.103 ± .005	0284H103
1/8"	.125 ± .005	0284H125
	.139 ± .007	0284H139
3/16"	.187 ± .007	0284H187
	.210 ± .007	0284H210
1/4"	.250 ± .008	0284H250
	.275 ± .008	0284H275
5/16"	.312 ± .010	0284H312
3/8"	.375 ± .010	0284H375
7/16"	.437 ± .010	0284H437
1/2"	.500 ± .012	0284H500

Style 0284

**Buna-N O-Ring Cord
70 Durometer**

Cross Section		Part Number
Nominal (Inches)	Actual (Inches)	
1/16"	.062 ± .005	0284062
	.070 ± .005	0284070
3/32"	.093 ± .005	0284093
	.103 ± .005	0284103
1/8"	.125 ± .005	0284125
	.139 ± .007	0284139
3/16"	.187 ± .007	0284187
	.210 ± .007	0284210
1/4"	.250 ± .008	0284250
	.275 ± .008	0284275
5/16"	.312 ± .010	0284312
3/8"	.375 ± .010	0284375
7/16"	.437 ± .010	0284437
1/2"	.500 ± .012	0284500
9/16"	.562 ± .012	0284562
5/8"	.625 ± .012	0284625
3/4"	.750 ± .016	0284750
13/16"	.812 ± .018	0284812
7/8"	.875 ± .020	0284875
1"	1.000 ± .020	02841
1 1/4"	1.250 ± .046	02841250
1 1/2"	1.500 ± .051	02841500

Style 0284S

**Buna-N O-Ring Cord
50 Durometer**

Cross Section		Part Number
Nominal (Inches)	Actual (Inches)	
1/8"	.139 ± .007	0284S139
3/16"	.210 ± .007	0284S210
1/4"	.275 ± .008	0284S275
5/16"	.312 ± .010	0284S312
3/8"	.375 ± .010	0284S375
1/2"	.500 ± .012	0284S500
5/8"	.625 ± .012	0284S625

Style 0285

**Neoprene O-Ring Cord
70 Durometer**

Cross Section		Part Number
Nominal (Inches)	Actual (Inches)	
1/16"	.070 ± .005	0285070
3/32"	.093 ± .005	0285093
	.103 ± .005	0285103
1/8"	.125 ± .005	0285125
	.139 ± .007	0285139
3/16"	.187 ± .007	0285187
	.210 ± .007	0285210
1/4"	.250 ± .008	0285250
	.275 ± .008	0285275
5/16"	.312 ± .010	0285312
3/8"	.375 ± .010	0285375
7/16"	.437 ± .010	0285437
1/2"	.500 ± .012	0285500
9/16"	.562 ± .012	0285562
5/8"	.625 ± .012	0285625
3/4"	.750 ± .016	0285750
1"	1.000 ± .020	02851



Style 0286

Silicone O-Ring Cord
70 Durometer

Cross Section		Part Number
Nominal (Inches)	Actual (Inches)	
1/16"	.070 ± .007	0286070
3/32"	.093 ± .007	0286093
	.103 ± .007	0286103
1/8"	.125 ± .007	0286125
	.139 ± .007	0286139
3/16"	.187 ± .007	0286187
	.210 ± .007	0286210
1/4"	.250 ± .008	0286250
	.275 ± .008	0286275
5/16"	.312 ± .008	0286312
3/8"	.375 ± .010	0286375
7/16"	.437 ± .012	0286437
1/2"	.500 ± .015	0286500
5/8"	.625 ± .015	0286625
3/4"	.750 ± .020	0286750
7/8"	.875 ± .039	0286875
1"	1.000 ± .051	02861

Style 0293

70 Durometer
Fluorelastomer Extrusion

Diameter (Inches)	Part Number
5/8" x 7/8"	0293625x875

Style 0294

60 Durometer
Silicone Extrusion

Diameter (Inches)	Part Number
1/2" x 1/2"	0294500
5/8" x 5/8"	0294625
5/8" x 7/8"	029725x875

Style 0295W

60 Durometer White
Neoprene Extrusion

Diameter (Inches)	Part Number
1/2" x 1/2"	0295W500

Style 0286T

70 Durometer
Silicone Tubing

Size (Inches)	Part Number
1/16" I.D. x 3/16" O.D.	0286T.062 ID x .187 OD
1/8" I.D. x 1/4" O.D.	0286T.125 ID x .250 OD

Style 0296

Buna-N O-Ring Cord
70 Durometer (Square)

Cross Section		Part Number
Nominal (Inches)	Actual (Inches)	
3/32"	.098 ± .007	0296098
1/8"	.133 ± .007	0296133
3/16"	.202 ± .010	0296202
1/4"	.264 ± .016	0296264
5/16"	.313 ± .020	0296313
3/8"	.375 ± .020	0296375
1/2"	.500 ± .025	0296500

Style 0287

Closed Cell Neoprene
Sponge Cord

Diameter (Inches)	Part Number
1/8"	0287125
3/16"	0287187
1/4"	0287250
5/16"	0287312
3/8"	0287375
1/2"	0287500
5/8"	0287625
3/4"	0287750
1"	02871

Style 0297

Fluoroelastomer
Square/Rectangular
Cord 75 Durometer

Cross Section		Part Number
Nominal (Inches)	Actual (Inches)	
1/8"	.125 ± .007	0297125
	.134 ± .007	0297134
3/16"	.187 ± .009	0297187
1/4"	.250 ± .010	0297250
5/16"	.313 ± .012	0297313
3/8"	.375 ± .012	0297375
3/8" x 1/2"	.375 x .500 ± .018	0297375X500
1/2"	.500 ± .018	0297500
5/8"	.625 ± .022	0297625
3/4"	.750 ± .025	0297750

Style 0292

60 Durometer EPR
Extrusion

Diameter (Inches)	Part Number
1/2" x 1/2"	0292500
5/8" x 5/8"	0292625
1/2" x 3/4"	029500 x 750



Style OM283V

Fluoroelastomer O-Ring Cord
75 Durometer (Metric)

Cross Section		Part Number
Millimeters	Inches	
2	.079 ± .004	OM283V2
2.4	.094 ± .005	OM283V2.4
2.5	.098 ± .005	OM283V2.5
3	.119 ± .005	OM283V3
3.5	.138 ± .006	OM283V3.5
4	.157 ± .007	OM283V4
4.5	.177 ± .008	OM283V4.5
5	.196 ± .008	OM283V5
5.7	.224 ± .010	OM283V5.7
6	.236 ± .010	OM283V6
7.5	.295 ± .010	OM283V7.5
8	.315 ± .012	OM283V8
9	.354 ± .013	OM283V9
10	.393 ± .014	OM283V10
12	.472 ± .018	OM283V12
14	.551 ± .020	OM283V14

Style 0Q283

Fluoroelastomer
Q-Ring Cord 75
Durometer

Cross Section		Part Number
Nominal (Inches)	Actual (Inches)	
1/16"	.070 ± .007	0Q283070
3/32"	.103 ± .007	0Q283103
1/8"	.139 ± .010	0Q283139
3/16"	.210 ± .012	0Q283210
1/4"	.275 ± .012	0Q283275
3/8"	.375 ± .014	0Q283375
1/2"	.500 ± .018	0Q283500

Style OM284B

Buna-N O-Ring Cord
70 Durometer (Metric)

Cross Section		Part Number
Millimeters	Inches	
1	.040 ± .005	OM284B1
2	.079 ± .005	OM284B2
2.4	.094 ± .005	OM284B2.4
2.5	.098 ± .005	OM284B2.5
3	.118 ± .006	OM284B3
4	.157 ± .007	OM284B4
4.5	.177 ± .007	OM284B4.5
5	.196 ± .007	OM284B5
5.7	.224 ± .007	OM284B5.7
6	.236 ± .007	OM284B6
7.5	.295 ± .008	OM284B7.5
8	.315 ± .010	OM284B8
8.4	.331 ± .010	OM284B8.4
9	.354 ± .010	OM284B9
10	.394 ± .010	OM284B10
12	.472 ± .010	OM284B12
13	.512 ± .012	OM284B13
14	.551 ± .015	OM284B14

Style 0Q284

Buna-N Q-Ring Cord
70 Durometer

Cross Section		Part Number
Nominal (Inches)	Actual (Inches)	
1/8"	.139 ± .010	0Q284139
3/16"	.210 ± .010	0Q284210
1/4"	.275 ± .010	0Q284275
1/2"	.500 ± .010	0Q284500



The APG Product Line

Industrial Hose Couplings

Ball Valves
Cam and Groove
EVER-TITE®
Tough-TITE™
U-TITE
Clamps
Double Bolt
High Pressure
Spiral
Steel Bands
Preformed
Open-end
Worm Gear
Combination Nipples
Foot Valves
Garden Hose
Gate Valves
Ground Joint
Menders
Nipples
Pin-lug
Push-on Hose Barbs
Standard Hose Barbs
Quick Disconnects
Sandblast
Strainers
Universal Crowfoot

Pressure Gauges

Dry – Black Steel w/Brass
Connections
Liquid Filled
Stainless Steel Case w/ Brass
Connections
All Stainless Steel

O-Rings

Aflas® 80 Durometer
Chloroprene 70 Durometer
E.P.R. 70 Durometer
Standard & Metric
E.P.R. Peroxide Cured
Standard 80 Durometer
Fluoroelastomer – Black
Standard 75 & 90 Durometer
Metric 75 & 90 Durometer
Fluoroelastomer – Brown
75 & 90 Durometer
Fluorosilicone 70 Durometer
Highly Saturated Nitrile
Green 70 Durometer
Standard & Metric
Black 90 Durometer
Blue TFE Coated 70
Durometer

O-Rings (continued)

Nitrile - Black
Standard 50, 70, & 90
Durometer
Metric 70 & 90 Durometer
Nitrile - Black - Peroxide Cured
90 Durometer
Nitrile - White 70 Durometer
PTFE
Silicone 70 Durometer
Standard & Metric
Square Cut Rings
Nitrile 70 Durometer
Teflon® Encapsulated
Viton® Core
Silicone Core
Urethane 70 & 90 Durometer
4 Lobe Q-Rings
Nitrile 70 Durometer
Fluoroelastomer 75
Durometer
Minnesota Quad-Rings®
*Available at ENA (an APG
subsidiary)*
Nitrile 70 Durometer
Viton® 70 Durometer
Non-Standard Sizes
(Vulcanized)
Kits
Standard
Metric
Splicing
Specialty
O-Ring Accessories
Measuring Devices
(Cones)
(Tapes)
(Sizing Charts)
(Gauges)
(Compound Identifiers)
Lubricants
Picks

Back-Up Rings

PTFE
Solid
Split
Spiral
Contoured Back-Up Rings
Nitrile 90 Durometer
Fluoroelastomer 90
Durometer
Leather

O-Ring Cord

Aflas® 75 Durometer
E.P.R. 70 Durometer
Fluoroelastomer - Black
Inch 75 & 90 Durometer
Metric 75 Durometer
Square 75 Durometer
Fluoroelastomer – Brown
75 Durometer
Neoprene 70 Durometer
Neoprene Sponge - Closed Cell
Nitrile
Inch – 50, 70, & 90 Durometer
Metric – 70 & 90 Durometer
Square – 70 Durometer
Silicone 70 Durometer
4-Lobe Q-Ring
Nitrile 70 Durometer
Fluoroelastomer 75
Durometer

Extrusions

EPDM
Fluoroelastomer
Neoprene - White
Neoprene Sponge - Closed Cell
Silicone - Gray

Hydraulic Seals

Loaded Lip Seals
Metal Clad Wipers
Metric Bonded Seals
Metric Compact Piston Seals
Metric Oil Seals
Metric U-Cups
Metric V Seals
Metric Wipers
Piston Cups
Rod Wipers
T-Seals
U-Cups
Vee Packings
Wear Rings
Wear Strips
WV Rings

Custom Molded Rubber Products

Mandrel Built & Lathe Cut
Products
Rubber Roll Coverings
Rubber / Fabric Products
Rubber to Metal Bonding



The APG Product Line (continued)

Sheet Material

Black Rubber Sponge -
Open Cell
Black Rubber - Cloth Inserted
Butyl
Chipboard
Compressed Non-Asbestos
Cork
Cork and Buna-N
Cork and Neoprene
Cork and Neoprene Spiral
Ribbon
Cork and Synthetic Rubber -
Adhesive Backed
EPDM
Felt – Gray, White, & Green
Fibre-Cork
Fiberglass Cloth
Fiberglass Wire Inserted
Tacky Cloth
Filled PTFE
Fish Paper
Flexible Graphite
Fluoroelastomer
Fluoroelastomer - Nylon Inserted
Gum Rubber
Hypalon
Leather
Koroseal®
Neoprene 40, 60, 70, &
72 Durometer
Neoprene Cotton and
Nylon Inserted
Nitrile 50, 60, & 90 Durometer
Nitrile - White 50-65 Durometer
Nitrile Sponge - Closed Cell
Nitrile Nylon Inserted
Nitrile - Transformer Grade
Nomex® Paper
Nylon
PCTFE
Plant (Vegetable) Fiber
Red Rubber
Silicone 50 and 70 Durometer
Silicone Sponge
Tank Gasket
TFE and TFE Glass Filled
Vinyl Matting
Vulcanized Fiber –
Bone Hard - Red

Fabrication

Gaskets
Water-jet Cut
Steel Rule Die Cut
Industrial Glass

Fabrication (continued)

Pipeline Scraper Discs
Stripping (with optional
adhesive backing)
Tank Strips & Gaskets
Vulcanizing
Non-Standard O-Rings
Sleeves
Gaskets

Spiral Wound Gaskets

304 Stainless Steel / Graphite
316 Stainless Steel / Graphite

Packing

Aramid Filament
Carbon / Graphite
Carbon / TFE
Flax and Flax / TFE
General Service Packing
G.F.O.®
Graphite Filament
Inconel Wire-Inserted
Novoloid Fiber / PTFE
Pre-Lubed TFE Yarn
Pre-Lubed TFE Yarn (FDA)
PTFE Cord Packing
Stuffing Box Packing (S.B.S.)
TFE Yarn
Twisted Fiberglass Rope & Wick

Industrial Glass

Tubular Gauge Glass
Standard
High Pressure
Red Line
Heavy Wall
Heavy Wall Red Line
Borosilicate Flat Glass
Circles
Rectangles
Squares
Flat Gauge Glass
Plain
High Pressure
Reflex
Vycor® Brand Flat Glass
Circles
Rectangles
Squares
Pyrex® Brand Annular Edge
Sight Glass
Annealed
Tempered

Industrial Glass (continued)

Fused Quartz
Circles
Rectangles
Squares
Glass Accessories
Guard Rods – Brass
Water Gauges – Brass
Gauge Glass Cutters
Gauge Glass Gaskets
PCTFE Shields
Mica Shields

Plastic Products

Replacement Safety Visors
Safety Visor Headgear
Safety Visor Hardhat Adapters
Replacement Lenses for
Sandblasting Helmets
Plastics for the Printing Industry
Custom Fabricated Die-Cut
Plastic Products

Specialty & Miscellaneous Products

Fastener Seals
Thread Seals
Tools
Gasket Cutters
Gasket Knives
Gauge Glass Cutters
Packing Hooks
O-Ring Picks
Punches & Punch Sets
Clamping System Tools
Tapes
Fiberglass
Kapton®
Polyester
Silicone Adhesive Backed –
Solid
Silicone Adhesive Backed –
Sponge
Teflon® Fiberglass
TFE Pipe Thread Tape
Adhesives
PTFE Flange Sealant
Stop-It® Pipe Repair System



Our Policy

Prices

Prices quoted are for acceptance within thirty days from date quoted. Unless specified, prices are based on our receiving order for quantities quoted.

Terms

Our terms of payment are 1% 10, net 30 days, unless other arrangements are made through our credit department.

Minimum Invoice

Orders consisting of O-Rings Only - \$5.00

Orders consisting of O-Rings and/or All Other Products (Excluding Plastic Products) - \$15.00

City Sales Counter - \$35.00

Plastic Products - \$50.00

Warranty

Products are warranted against defects in workmanship and defects in material. Products having such defects will be replaced or credited as APG elects. Liability is limited to the invoice value of the defective item. Our responsibility shall not exceed the original purchase price of the defective product. In any event, APG shall not be held responsible for any special or consequential damages. In all cases, please contact us for approval and routing of return items. All claims of shortage or damage must be made within 30 days after receipt of shipment.

Freight

All orders totaling less than \$1500 at NET prices are F.O.B. our warehouse with no freight allowance. Orders totaling \$1500 or more at NET prices, any product mix, receive full freight prepaid and allowed, provided such orders are for one shipment within the lower 48 continental United States and provided our normal freight modes are used. Special delivery charges incurred at the customer's request are for the customer's account. Exceptions to this freight prepaid and allowed policy: all glass products. These products are F.O.B. our warehouse with no freight allowance unless other items on the order total \$1500 or more at NET prices.

Catalog Information

Various information sources were used to compile this catalog. We offer this information only as a guide and cannot assume responsibility for accuracy of the data herein. Prices listed are current, subject to change.



“America’s Most Responsive Warehouse”

www.callapg.com

(713) 675-5271

1-800-888-5223

email info@callapg.com

FAX: (713) 675-2730

FAX: 1-800-444-3252

P.O. Box 213 (77001)

6039 Armour Dr. (77020)

Houston, Texas